

For Your Convenience

Please contact Sony directly if you:

- Have questions on the use of your television after reading your manual
- Experience difficulty operating your television

Contact Sony Customer Support at:

<http://www.sony.com/tvsupport>

or to speak with a support representative:

United States

1-800-222-SONY (7669)

8:00 AM - 10:00 PM (EST) Mon - Fri

10:30 AM - 7:15 PM (EST) Sat - Sun

Canada

1-877-899-SONY (7669)

8:00 AM - 6:00 PM (Eastern)

8:00 AM - 5:00 PM (Western)

Sony will work to resolve your questions more quickly than your retailer or place of purchase.

Please Do Not Return the Product to the Store

SXRD

Silicon X-tal Reflective Display



<http://www.sony.net/>

Printed in U.S.A.

SXRD Projection TV Operating Instructions

KDS-R60XBR2

KDS-R70XBR2



Owner's Record

The model and serial numbers are located at the rear of the TV. Record these numbers in the spaces provided below. Refer to them whenever you call upon your Sony dealer regarding this product.

Model No. _____

Serial No. _____

For Your Convenience

Please contact Sony directly if you:

- Have questions on the use of your television after reading your manual
- Experience difficulty operating your television

Contact Sony Customer Support at:

<http://www.sony.com/tvsupport>

or to speak with a support representative:

United States

1-800-222-SONY (7669)

8:00 AM - 10:00 PM (EST) Mon - Fri

10:30 AM - 7:15 PM (EST) Sat - Sun

Canada

1-877-899-SONY (7669)

8:00 AM - 6:00 PM (Eastern)

8:00 AM - 5:00 PM (Western)

Sony will work to resolve your questions more quickly than your retailer or place of purchase.

Please Do Not Return the Product to the Store

WARNING

To reduce the risk of fire or electric shock, do not expose this apparatus to rain or moisture.

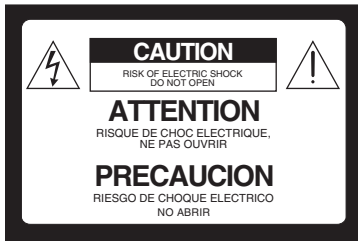

This symbol is intended to alert the user to the presence of uninsulated “dangerous voltage” within the product’s enclosure that may be of sufficient magnitude to constitute a risk of electric shock to persons.



This symbol is intended to alert the user to the presence of important operating and maintenance (servicing) instructions in the literature accompanying the appliance.

The apparatus shall not be exposed to dripping or splashing and no objects filled with liquids, such as vases, shall be placed on the apparatus.

CAUTION

To prevent electric shock, do not use this polarized AC plug with an extension cord, receptacle or other outlet unless the blades can be fully inserted to prevent blade exposure.

Note on Caption Vision

This TV provides display of TV closed captioning in accordance with §15.119 of the FCC rules.

Declaration of Conformity

Trade Name: SONY
 Model: KDS-R60XBR2/KDS-R70XBR2
 Responsible Party: Sony Electronics Inc.
 Address: 16530 Via Esprillo,
 San Diego, CA 92127 U.S.A.
 Telephone Number: 858-942-2230

This device complies with part 15 of the FCC rules. Operation is subject to the following two conditions: (1) This device may not cause harmful interference, and (2) this device must accept any interference received, including interference that may cause undesired operation.

NOTIFICATION

This equipment has been tested and found to comply with the limits for a Class B digital device, pursuant to Part 15 of the FCC Rules. These limits are designed to provide reasonable protection against harmful interference in a residential installation. This equipment generates, uses and can radiate radio frequency energy and, if not installed and used in accordance with the instructions, may cause harmful interference to radio communications. However, there is no guarantee that interference will not occur in a particular installation. If this equipment does cause harmful interference to radio or television reception, which can be determined by turning the equipment off and on, the user is encouraged to try to correct the interference by one or more of the following measures:

- Reorient or relocate the receiving antenna.
- Increase the separation between the equipment and receiver.
- Connect the equipment into an outlet on a circuit different from that to which the receiver is connected.
- Consult the dealer or an experienced radio/TV technician for help.

Pursuant to FCC regulations, you are cautioned that any changes or modifications not expressly approved in this manual could void your authority to operate this equipment.

For Customers in Canada

This Class B digital apparatus complies with Canadian ICES-003.

Safety

- Operate the TV only on 120 V AC.
- The plug is designed, for safety purposes, to fit into the wall outlet only one way. If you are unable to insert the plug fully into the outlet, contact your dealer.
- If any liquid or solid object should fall inside the cabinet, unplug the TV immediately and have it checked by qualified service personnel before operating it further.
- If you will not be using the TV for several days, disconnect the power by pulling the plug itself. Never pull on the cord.
- For details concerning safety precautions, see “Important Safety Instructions” on page 5.

Installing

- The TV should be installed near an easily accessible power outlet.
- To prevent internal heat buildup, do not block the ventilation openings.
- Do not install the TV in a hot or humid place, or in a place subject to excessive dust or mechanical vibration.
- Use the TV at temperatures between 41°F (5°C) and 95°F (35°C).
- If the TV is transported directly from a cold to a warm location, or if the room temperature changes suddenly, the picture may be blurred or show poor color due to moisture condensation. In this case, please wait a few hours to let the moisture evaporate before turning on the TV.
- To obtain the best picture, do not expose the screen to direct illumination or direct sunlight. It is recommended to use spot lighting directed down from the ceiling or to cover the windows that face the screen with opaque drapery. It is desirable to install the TV in a room where the floor and walls are not of a reflective material.
- See pages 11-14 for more information on the installation.

CAUTION

Use the following Sony appliance(s) only with the following TV STAND. Use with other TV STAND may cause instability and possibly result in injury.

	SONY APPLIANCE MODEL NO.	
	KDS-R60XBR2	KDS-R70XBR2
SONY TV STAND MODEL NO.	SU-RS51U	

To Customers

Sufficient expertise is required for installing the specified product. Be sure to subcontract the installation to Sony dealers or licensed contractors and pay adequate attention to safety during the installation.

(Continued)

Note

This digital television is capable of receiving analog basic and digital basic television programming by direct connection to a cable system providing such programming. Certain premium, advanced and interactive digital cable services such as video-on-demand, a cable operator's enhanced program guide and data-enhanced television services may require the use of a set-top box. For more information call your local cable operator.

This television includes a QAM demodulator which should allow you to receive unscrambled digital cable television programming via subscription service to a cable service provider. Availability of digital cable television programming in your area depends on the type of programming and signal provided by your cable service provider.

Trademark Information

In the United States, TV Guide and other related marks are registered marks of Gemstar-TV Guide International, Inc. and/or one of its affiliates. In Canada, TV Guide is a registered mark of Transcontinental Inc., and is used under license by Gemstar-TV Guide International, Inc.

The TV Guide On Screen system is manufactured under license from Gemstar-TV Guide International, Inc. and/or one of its affiliates.

The TV Guide On Screen system is protected by one or more of the following United States patents 4,908,713; 6,498,895; 6,850,693; 6,396,546; 5,940,073; 6,239,794 to Gemstar-TV Guide International, Inc. and/or its subsidiaries.

CableCARD™ is a trademark of Cable Television Laboratories, Inc.



TruSurround XT, SRS and (●) symbol are trademarks of SRS Labs, Inc. TruSurround XT technology is incorporated under license from SRS Labs, Inc.



Manufactured under license from BBE Sound, Inc.

Licensed by BBE Sound, Inc. under one or more of the following US patents: 5510752, 5736897. BBE and BBE symbol are registered trademarks of BBE Sound, Inc.

Macintosh is a trademark licensed to Apple Computer, Inc., registered in the U.S.A and other countries.

Blu-ray Disc is a trademark.

SXRD, WEGA, Grand WEGA, Steady Sound, Digital Reality Creation, CineMotion and Twin View are registered trademarks of Sony Corporation.



This TV is manufactured under license from Dolby Laboratories. "Dolby" and the double-D symbol are trademarks of Dolby Laboratories.

This TV incorporates High-Definition Multimedia Interface (HDMI™) technology. HDMI, the HDMI logo and High-Definition Multimedia Interface are trademarks or registered trademarks of HDMI Licensing LLC.

Important Safety Instructions

- 1) Read these instructions.
- 2) Keep these instructions.
- 3) Heed all warnings.
- 4) Follow all instructions.
- 5) Do not use this apparatus near water.



- 6) Clean only with dry cloth.



- 7) Do not block any ventilation openings. Install in accordance with the manufacturer's instructions.

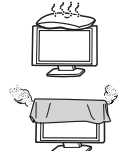

- 8) Do not install near any heat sources such as radiators, heat registers, stoves, or other apparatus (including amplifiers) that produce heat.



- 9) Do not defeat the safety purpose of the polarized or grounding-type plug. A polarized plug has two blades with one wider than the other. A grounding type plug has two blades and a third grounding prong. The wide blade or the third prong are provided for your safety. If the provided plug does not fit into your outlet, consult an electrician for replacement of the obsolete outlet.



- 10) Protect the power cord from being walked on or pinched particularly at plugs, convenience receptacles, and the point where they exit from the apparatus.



- 11) Only use attachments/accessories specified by the manufacturer.



- 12) Use only with the cart, stand, tripod, bracket, or table specified by the manufacturer, or sold with the apparatus. When a cart is used, use caution when moving the cart/apparatus combination to avoid injury from tip-over.



- 13) Unplug this apparatus during lightning storms or when unused for long periods of time.



- 14) Refer all servicing to qualified service personnel. Servicing is required when the apparatus has been damaged in any way, such as power-supply cord or plug is damaged, liquid has been spilled or objects have fallen into the apparatus, the apparatus has been exposed to rain or moisture, does not operate normally, or has been dropped.



- Be sure to observe the TV's "For Safety" section on page 6.

Antennas

Outdoor Antenna Grounding

If an outdoor antenna is installed, follow the precautions below. An outdoor antenna system should not be located in the vicinity of overhead power lines or other electric light or power circuits, or where it can come in contact with such power lines or circuits.

WHEN INSTALLING AN OUTDOOR ANTENNA SYSTEM, EXTREME CARE SHOULD BE TAKEN TO KEEP FROM CONTACTING SUCH POWER LINES OR CIRCUITS AS CONTACT WITH THEM IS ALMOST INVARIABLY FATAL.

Be sure the antenna system is grounded so as to provide some protection against voltage surges and built-up static charges.

Section 810 of the National Electrical Code (NEC) in USA and Section 54 of the Canadian Electrical Code in Canada provides information with respect to proper grounding of the mast and supporting structure, grounding of the lead-in wire to an antenna discharge unit, size of grounding conductors, location of antenna discharge unit, connection to grounding electrodes, and requirements for the grounding electrode.

(Continued)

Antenna Grounding According to the NEC

Refer to section 54-300 of Canadian Electrical Code for Antenna Grounding.

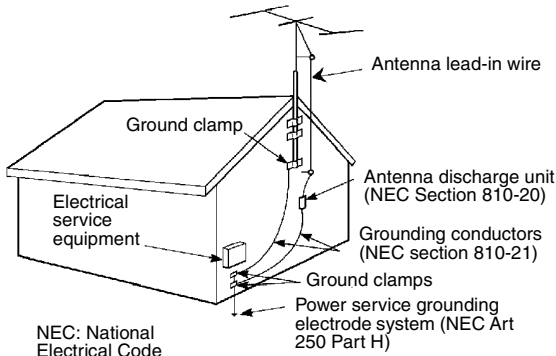

Cleaning

- Clean the rear cover area of the TV regularly. Dust in the rear cover area may cause a problem with the cooling system of the TV set.
- Clean the cabinet of the TV with a dry soft cloth. To remove dust from the screen, wipe it gently with a soft cloth. Stubborn stains may be removed with a cloth slightly dampened with solution of mild soap and warm water. Never use strong solvents such as thinner or benzine for cleaning. If the picture becomes dark after using the TV for a long period of time, it may be necessary to clean the inside of the TV. Consult qualified service personnel.
- Unplug the AC power cord when cleaning this unit. Cleaning this unit with a plugged AC power cord may result in electric shock.



On Contamination on the Screen Surface

The screen surface has a special coating to reduce reflections. To prevent screen damage, clean the screen as follows:

- Clean the screen with a soft cloth.
- To remove hard contamination, use a cloth moistened with a solution of mild soap and warm water. Do not spray cleaning solution directly onto the TV. It should only be sprayed to moisten the cleaning cloth.
- Do not use any type of abrasive pad, alkaline cleaner, acid cleaner, scouring powder, chemical cloth, or solvent such as alcohol, benzene or thinner, as these may scratch the screen's coating.

Service

Damage Requiring Service

Do not attempt to service the set by yourself since opening the cabinet may expose you to dangerous voltage or other hazards.

Unplug the set from the wall outlet and refer servicing to qualified service personnel.



Replacement Parts

When replacement parts are required, be sure the service technician certifies in writing that he has used replacement parts specified by the manufacturer that have the same characteristics as the original parts.

Unauthorized substitutions may result in fire, electric shock or other hazards.

See "Replacing the Lamp" on page 66.

For Safety

Be Careful When Moving the TV

When you place the TV in position, be careful not to drop it on your foot or fingers.

Watch your footing while installing the TV.

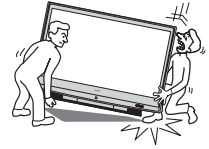

Carry the TV in the Specified Manner

If you carry the TV in a manner other than the specified manner and without the specified number of persons, it may drop and a serious injury may be caused. Be sure to follow the instructions mentioned below.

- Carry the TV with the specified number of persons (see page 11).
- Hold the TV tightly when carrying it.
- Before carrying the TV, disconnect any accessories or cables.

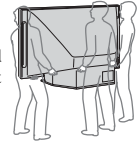

About the TV

Although the TV is made with high-precision technology, black dots may appear or bright points of light (red, blue, or green) may appear constantly on the screen. This is a structural property of the panel and is not a defect.

Installation

- If direct sunlight or other strong illumination shines on the screen, part of the screen may appear white due to reflections from behind the screen. This is a structural property of the TV. Do not expose the screen to direct illumination or direct sunlight.
- The picture quality may be affected by your viewing position. For the best picture quality, install your TV according to "Recommended Viewing Area" on page 15.
- When installing your TV against a wall, keep it at least 4 inches (10 cm) away from the wall.

Projection Lamp

- Your TV uses a projection lamp as its light source. It is time to replace the lamp with a new one (not supplied) when:
 - the message, "Projection lamp is nearing end of life. Please replace the lamp," appeared on the screen,
 - the lamp replacement indicator on the front panel blinks in red,
 - screen images become dark,
 - no image appears on the display after prolonged use.
- In rare instances, the bulb may pop inside the lamp unit, but the lamp unit is designed to contain all of broken glass pieces inside the lamp unit. (See "Replacing the Lamp" on page 66.)
- When the lamp eventually burns out, you may hear a noticeable pop sound. This is normal and is inherent in this type of lamp.

Cooling Fan

This TV uses a cooling fan. You may hear the noise of fan running, depending on the placement of your TV. The noise may be more noticeable during the night or when the background noise level is low.

Objects and Ventilation Holes

Never push objects of any kind into the unit through the cabinet slots as they may touch dangerous voltage points or short out parts that could result in a fire or electric shock. Never spill liquid of any kind on the unit.



Disposal of Used Batteries

To preserve our environment, dispose of used batteries according to your local laws or regulations.

Contents

Getting Started

Welcome	8
Features	8
Notes on the TV	9
Screen	10
Projection Lamp	10
Installing the TV	11
Carrying Your TV	11
Take Precaution during Installation	11
Preventing the TV from Toppling Over	11
When Installing Your TV against a Wall	12
Detaching the Speakers (KDS-R70XBR2 only)	13
Recommended Viewing Area	15
Connecting the TV	16
Cable System and VHF/UHF Antenna System	16
Cable Box/Digital Cable Box and Antenna	16
Cable Box/Digital Cable Box	17
Satellite Receiver and Cable/Antenna	17
VCR and Cable	18
VCR and Cable Box/Digital Cable Box	19
Using the CableCARD Device	20
About Using the CableCARD Device	20
Activating CableCARD Service	20
Removing the CableCARD Device	21
When Connecting to Optional Equipment	22
Front Panel	22
Rear Panel	23
Setting Up the Channel List - Initial Setup	26

Basic Operations

Remote Control	28
Programming the Remote Control	32
Using Other Equipment with Your Remote Control	34
TV Controls	37

Using the TV Guide On Screen System

Overview of the TV Guide On Screen System	38
Navigating the TV Guide On Screen System	39
TV Guide On Screen System Components	40
LISTINGS Service	42
SEARCH Service	43
SCHEDULE Service	45
SETUP Service	46

Using the Menus

Overview of MENU	47
Picture Settings	49
Sound Settings	52
Screen Settings	54
Channel Settings	56
Parental Lock Settings	57
Setup Settings	60
PC Settings	64

Other Information

Replacing the Lamp	66
How to Replace the Lamp	66
Troubleshooting	70
TV Guide On Screen System	70
Remote Control	71
CableCARD Device	72
Twin View	72
Picture	72
Sound	74
Channels	74
General	75
PC Input Signal Reference Chart	77
Specifications	78
Index	79

Getting Started

Welcome

Thank you for purchasing this Sony SXRDTM projection TV. This manual is for models KDS-R60XBR2 and KDS-R70XBR2.

Features

Some of the features that you will enjoy with your new TV include:

- ❑ **SXRDTM:** SXRDTM is a Silicon X-tal Reflective Display technology that delivers high-level resolution, greater contrast ratio, faster response speed and film-like reproduction compared to other conventional devices.
- ❑ **WEGA Engine:** Delivers superb picture quality from any video source by minimizing the signal deterioration caused by digital-to-analog conversion and stabilizing the signal processing. This engine features unique Sony technology, including:
 - **DRC® (Digital Reality Creation)-MF V2.5:** Unlike conventional line doublers, the DRC Multifunction feature replaces the signal's NTSC waveform with the near-HD equivalent by digital mapping processing. The DRC Palette option lets you customize the level of detail (Reality) and smoothness (Clarity).
- ❑ **Integrated HDTV:** You can watch digital televised programs and enjoy the improved audio/video quality offered by these programs.
- ❑ **Advanced Iris:** Automatically detects the brightness of the screen. By adjusting the iris shutter, this feature can provide you with the best contrast and brightness from one scene to the next for your TV viewing.
- ❑ **Wide Screen Mode:** Allows you to watch 4:3 normal broadcasts in wide screen mode (16:9 aspect ratio).
- ❑ **CineMotion®:** Using the reverse 3-2 pull down technology, the CineMotion feature provides smoother picture movement when playing back movies or other video sources on film.
- ❑ **Twin View®:** Twin View allows you to watch two programs side by side with the ability to zoom in on one picture and listen to the program in the selected window. You can watch pictures from two different sources (480i) simultaneously.
- ❑ **MENU:** Sony's unique user interface provides easy access to the popular and useful TV functions such as external inputs (switch among connected equipment), favorite channels (create a list of your favorite channels), TV Guide On Screen™ system, cable channels (view cable channels), antenna channels (view antenna channels) or to customize your TV settings.
- ❑ **Parental Control:** Downloadable digital rating and V-Chip technology allows parents to block unsuitable programming from younger viewers.

- ❑ **CableCARD™ slot:** Provides cable subscribers with access to digitally encrypted cable channels — without the need for a set-top box — that will enable you to receive not only standard definition but also high definition television. The CableCARD device, which is provided by your cable TV company, is inserted into the TV's rear panel CableCARD slot. After the service is activated with your cable TV company, the card replaces the need for a separate set-top box. (Check with your cable TV company about CableCARD service details, limitations, pricing, and availability. For more information about CableCARD device in this manual, see page 20.)
- ❑ **Component Video Inputs:** Offers a high-quality video for DVD (480p, 480i) and digital set-top box (1080i, 720p, 480p, 480i) connections.
- ❑ **S VIDEO Inputs:** Provides high-quality image from connected equipment.
- ❑ **Favorite Channels:** Using the MENU function, you can view and select from a list of up to 16 favorite channels without leaving the current channel.
- ❑ **TV Guide On Screen™ System:** The interactive program guide offers up to eight days of program listings, as well as program search and reminder features.
- ❑ **Steady Sound®:** Equalizes volume levels so there is consistent output between programs and commercials.
- ❑ **PC Input:** Allows you to connect your PC and display the PC screen on your TV.
- ❑ **HDMI (High-Definition Multimedia Interface):** Provides an uncompressed, all-digital audio/video interface between this TV and any HDMI-equipped audio/video component, such as a set-top box, Blu-ray Disc™ Player (BD), DVD player, and A/V receiver. HDMI supports enhanced, or high-definition video, plus two-channel digital audio.

Notes on the TV

To enjoy clear picture

- ❑ Prevent sunlight or other light sources from shining directly onto the screen.
- ❑ The screen surface is easily scratched. Do not rub, touch, or tap it with sharp or abrasive objects (see “On Contamination on the Screen Surface” on page 6).

When not using the TV for a long period of time

- ❑ Unplug the AC power cord from the outlet if you anticipate not using the TV for more than a week.

When turning off the power

- ❑ The cooling fan will continue to operate for about two minutes. Allow several minutes before unplugging from the outlet or switching the breaker off.

(Continued)

On moisture condensation

- ❑ If your TV is moved directly from a cold to a warm location or is placed in a humid room, or if the room temperature changes suddenly, the picture may blur or show poor color. This is caused by moisture condensation on the lenses inside. Wait a few hours to let the moisture evaporate before turning on the TV. When the condensation has evaporated, the picture will return to normal.

Screen

To minimize reflection, the screen surface has a special coating. Inappropriate cleaning methods could damage the screen surface. Special care is required.

Cleaning the Screen Surface

Dust and dirt on the screen can affect the picture quality. To dust off the screen use a soft cloth. Be sure to follow the cleaning instruction on page 6 for stubborn stains and dirt.

Temporary Image Retention

When high contrast non-moving images such as station logos and channel numbers are displayed for a long period of time, there may be some image retention on the screen. This is only a temporary condition. Turning off the power for a while or letting the TV run on another channel will eliminate the retained image.

Projection Lamp

To replace the lamp,
see page 66.

Your TV uses a projection lamp as its light source. As with any lamp, it has a lifespan and needs to be replaced when the LAMP LED blinks or the screen becomes darker. Your TV also has a function to display a message “Projection lamp is nearing end of life. Please replace the lamp.” to let you know that the lamp has reached its expected lifespan. Note the following:

- ❑ After turning on your TV, it may take a while (1 minute or less) before the picture appears.
- ❑ When the projection lamp wears out, the screen goes dark. Replace the lamp with the supplied Sony XL-5300 lamp.
- ❑ After the lamp is replaced, set the **Lamp Replacement** option in the **Setup** settings (see page 62).

- 🔧 Until you set the **Lamp Replacement** option, a message announcing that the lamp is at the end of its life will appear every time you turn on your TV.
- 🔧 The light emitted from the lamp is quite bright when your TV is in use. To avoid eye discomfort or injury, do not look into the light housing when the power is on.

Installing the TV

Carrying Your TV

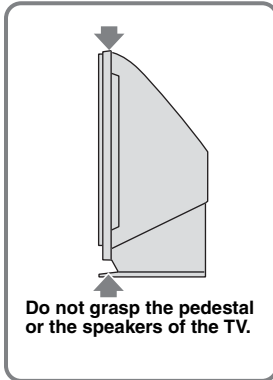

Carrying the TV requires at least three people. Do not hold by the pedestal or the speakers of the TV. Doing so may cause these parts to break off. When moving the TV, one person should lift the back, and the other two people should lift the front and sides. Support the TV by placing your hands in the holes on the lower part of the TV set, and then lift carefully.

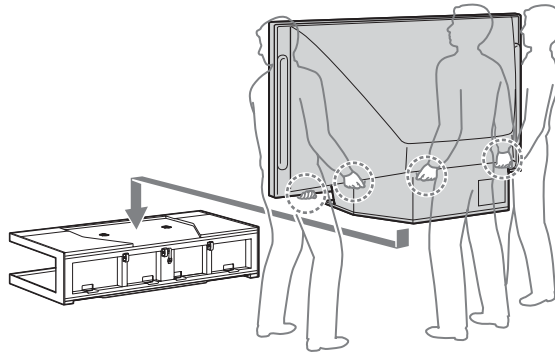

If you have connected cables and cords, be sure to unplug them before moving the TV.

Take Precaution during Installation

To ensure the safety of children and the TV, keep children away from the TV during installation. Climbing on or pushing the TV or its stand may cause it to fall and damage the TV.

Preventing the TV from Toppling Over

As a protective measure, secure the TV as follows.

Using the TV stand with support belts

- Sony strongly recommends using the TV stand SU-RS51U with a support belt designed for your TV.

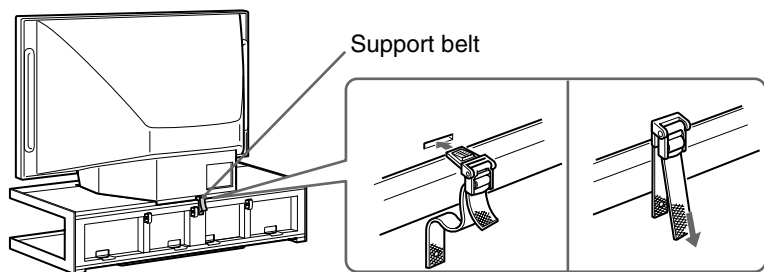

 When using the SU-RS51U stand for your TV, you must use the support belt.

When Installing Your TV against a Wall

Keep your TV at least 4 inches (10 cm) away from the wall to provide proper ventilation. Blocking the ventilation opening of the cooling fan may damage the TV.

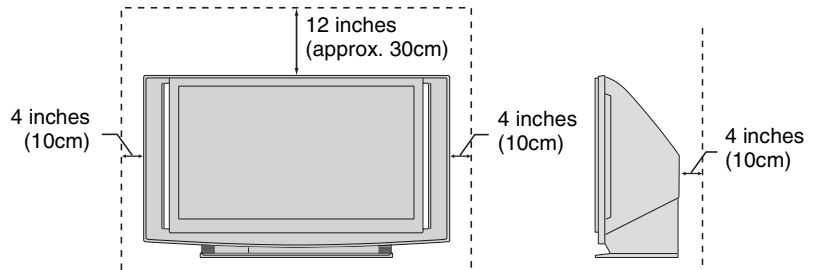

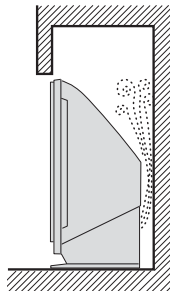

Never install the TV as follows

Air circulation is blocked

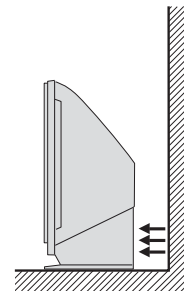

Air blown into the cooling fan



 Do not install the TV near any ventilation, as it may affect the normal TV operating temperature.

Detaching the Speakers

(KDS-R70XBR2 only)

The speakers on the KDS-R70XBR2 can be detached if required. If you use a multi-channel surround speaker system and there is insufficient space to install the display unit, we recommend using the speakers detached.

- 1 Remove the three screws that are located on the rear of the speaker, and pull the speaker straight out to detach it from the panel. When removing the screws, use a coin to turn them counterclockwise.

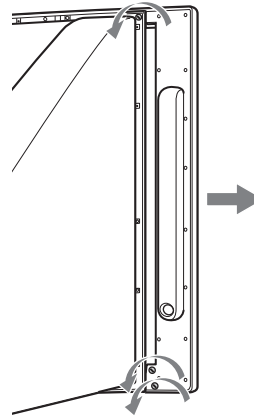

- 2 Attach the side cover that came in the box. Press the cover at the top, middle, and bottom to make sure that it is attached securely (see illustration).

 Facing the TV, make sure that the side covers marked "R" (right) and "L" (left) are attached to the corresponding sides of the TV.

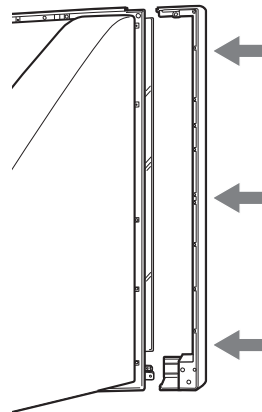

(Continued)

- 3** Tighten the side cover with the three screws that you removed in step 1. When attaching the screws, use a coin to turn them clockwise.

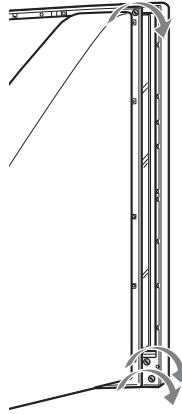

- 4** Repeat steps 1 through 3 with the speaker on the other side.



After you remove the speakers, place them in the box that originally contained the side cover.

Recommended Viewing Area

Your viewing position may affect the picture quality. For the best picture quality, install your TV within the areas shown below.

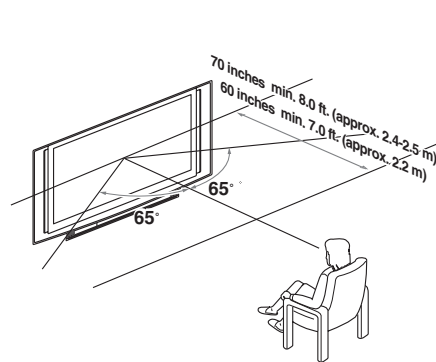

Model	Viewing distance
KDS-R60XBR2	min. 7.0 ft. (approx. 2.2 m)
KDS-R70XBR2	min. 8.0 ft. (approx. 2.4 - 2.5 m)

Horizontal Viewing Area

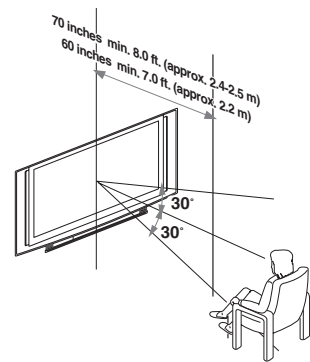

Vertical Viewing Area



-  Install the TV in a location that avoids reflections from external light sources.
-  Reflections from external light sources may cause unwanted illuminations in certain areas of the picture (typically dark areas). These types of illuminations can occur with the TV's power on or off.

Connecting the TV

To display clear crisp pictures, you must connect your TV correctly and select the correct **Wide Mode** to display the picture in the correct aspect ratio (see “Changing the Wide Screen Mode” on page 31). It is strongly recommended that you connect the antenna/cable input using 75-ohm coaxial cable to receive optimum picture quality signal. A 300-ohm twin lead cable can be easily affected by radio noise and the like, resulting in signal deterioration. If you use a 300-ohm twin lead cable, keep it as far away from the TV as possible. Do not use an indoor antenna, which is especially susceptible to radio noise.

You can also connect a variety of optional equipment to your TV (see page 17). For multiple equipment connections, please refer to the separate Quick Setup Guide.

Cable System and VHF/UHF Antenna System

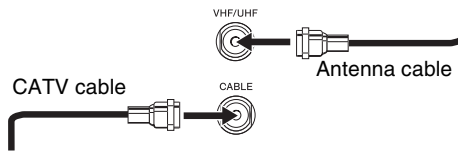

Press ANT to switch between VHF/UHF and cable.

Cable Box/Digital Cable Box and Antenna

To change channels using the cable box, set your TV to channel 3 or 4 depending on the cable box channel output.

Use this hookup if

- Your cable company scrambles some channels, such as premium channels. Viewing all channels requires a cable box.
- You do not intend to hook up any other audio or video equipment to your TV.

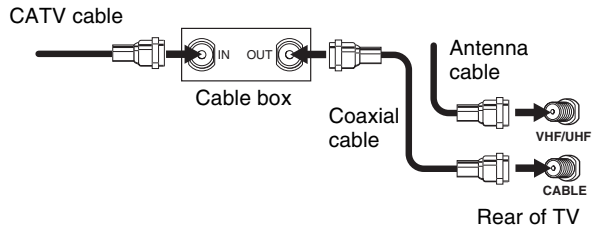

To set up the TV remote control, see “Programming the Remote Control” on page 32.

Press SAT/CABLE to begin operating the cable box with the remote control (see page 28). The indicator will light up.

Press ANT to switch between VHF/UHF and cable.

Cable Box/ Digital Cable Box

💡 To change channels using the cable box, set your TV to channel 3 or 4 depending on the cable box channel output.

Use this hookup if

- You subscribe to a cable TV system that uses scrambled or encoded signals requiring a cable box to view all channels, and
- You do not intend to hook up any other audio or video equipment to your TV.

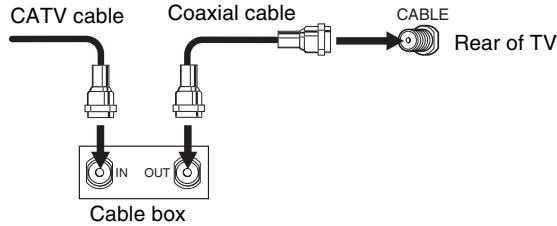

- 🔧 To set up the TV remote control, see “Programming the Remote Control” on page 32.
- 🔧 Press SAT/CABLE to begin operating the cable box with the remote control (see page 28). The indicator will light up.

Satellite Receiver and Cable/Antenna

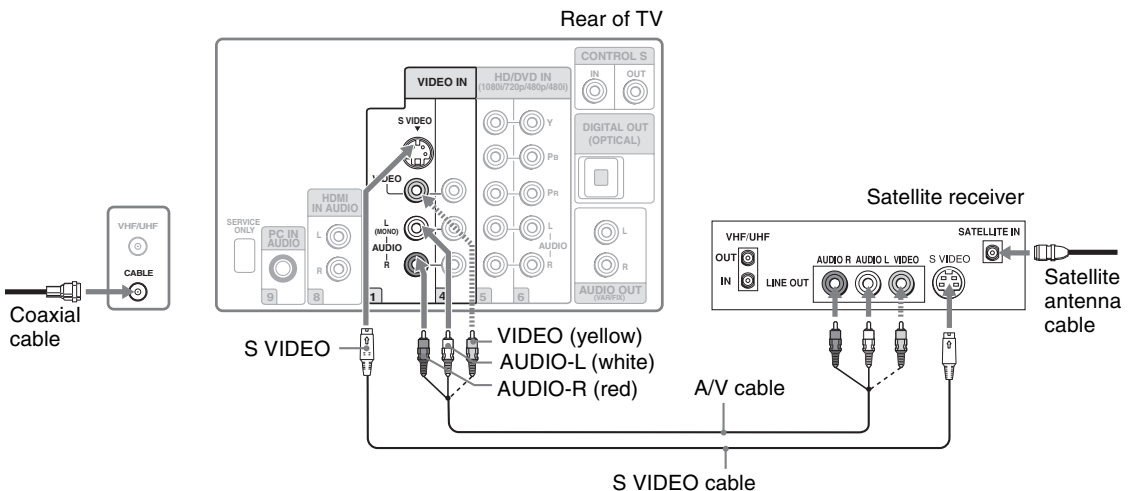

- 🔧 If your satellite receiver is not equipped with S VIDEO, use a VIDEO cable (yellow) instead of the S VIDEO cable.

VCR and Cable

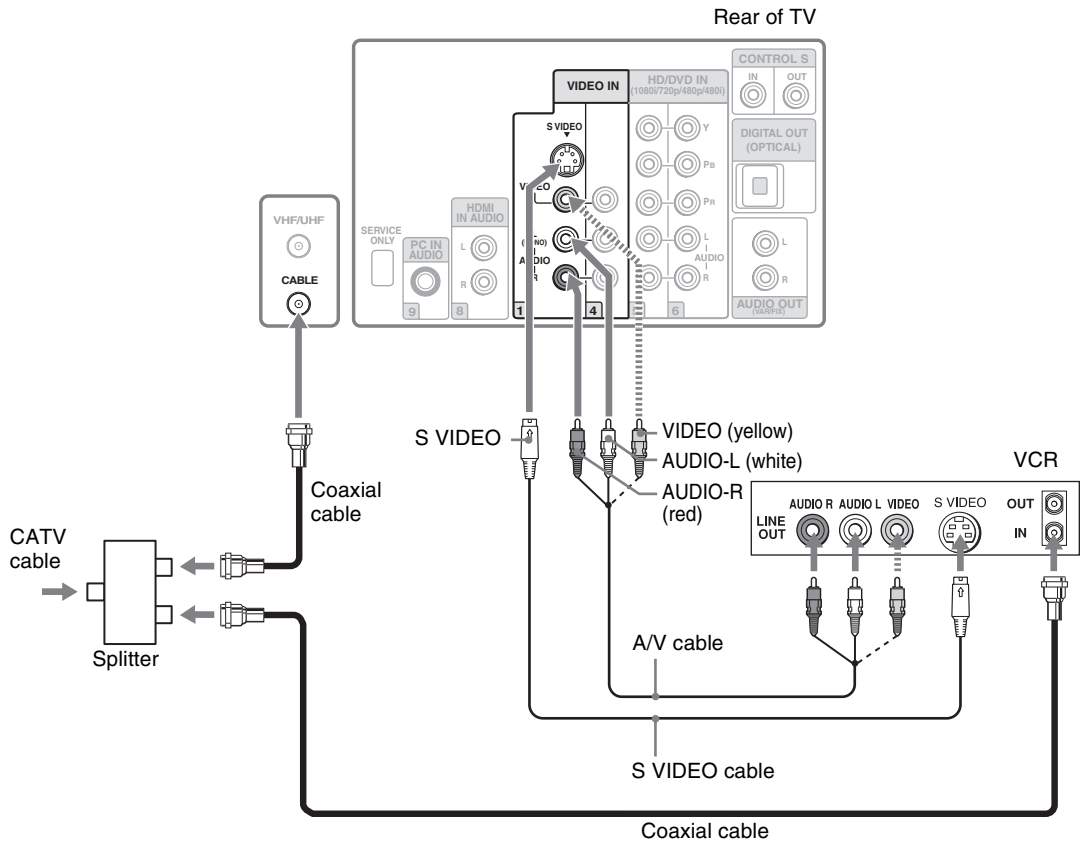

 If your VCR is not equipped with S VIDEO, use a VIDEO cable (yellow) instead of the S VIDEO cable.

**VCR and Cable Box/
Digital Cable Box**

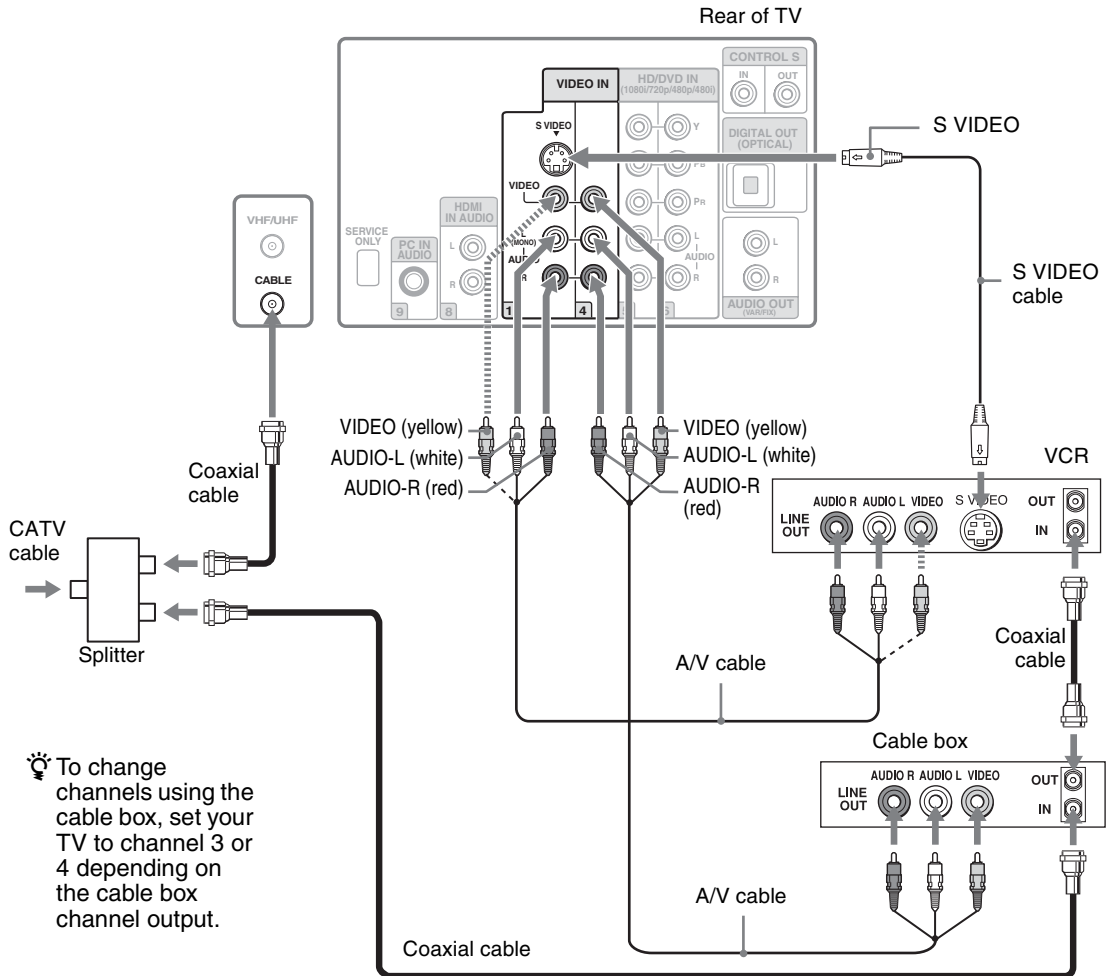

- ✎ If your VCR is not equipped with S VIDEO, use a VIDEO cable (yellow) instead of the S VIDEO cable.
- ✎ If you are connecting a digital cable box, you will need a special bidirectional splitter designed to work with your cable box.

Using the CableCARD Device

The CableCARD device provides cable subscribers with access to digitally encrypted cable channels — without the need for a set-top box — that will enable you to receive not only standard definition but also high definition television. The CableCARD device, which is provided by your cable TV company, is inserted into the TV's rear panel CableCARD slot. After the service is activated with your cable TV company, the card replaces the need for a separate set-top box.

About Using the CableCARD Device

If you are planning to use a separate cable box for digital cable TV services, you may be able to receive programming using this TV with the CableCARD device instead — except in the following circumstances:

- ❑ Your cable TV company does not provide CableCARD service in your viewing area.
- ❑ You want to access your cable TV company's interactive or advanced features (such as video-on-demand or, in some cases, pay-per-view). At this time, these services require a bidirectional link, which are only available through the use of a separate set-top box. CableCARD device is currently a unidirectional device only, and cannot provide these advanced services.

Check with your cable TV company for CableCARD service details, limitations, pricing, and availability, all of which are determined by your cable TV company — not Sony.

Activating CableCARD Service

Before you can use CableCARD service, you need to insert the CableCARD device (supplied by your cable TV company) and activate the service, as described below:

- 1 Insert the CableCARD device into the CableCARD slot.

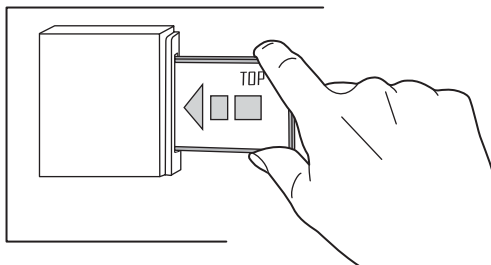

 **CAUTION:** When inserting the CableCARD device, the top side of the card should face front. Inserting the CableCARD incorrectly may result in permanent damage to the card and the TV.

- 2 Gently push the card into the slot until it locks into place.

 You can also access information about your CableCARD device in the Channel settings (see page 56).

- 3 The CableCARD device setup screen is automatically displayed. This screen includes information your cable TV company will request before they can activate your service.
- 4 Follow the displayed instructions: Phone your cable TV company. A representative will guide you through the activation process.
- 5 After your CableCARD device is activated, your cable TV company will download the service information, including the channel list, to the CableCARD device. After the CableCARD device has acquired channels from your cable TV company, the TV tunes to the lowest available channel.

Removing the CableCARD Device

In the event you want to cancel your service, contact your cable TV company.

 Once the CableCARD device is removed, your TV will no longer decrypt digital cable TV programming services that require CableCARD.

- 1 Push the eject button on the CableCARD slot to release the card.

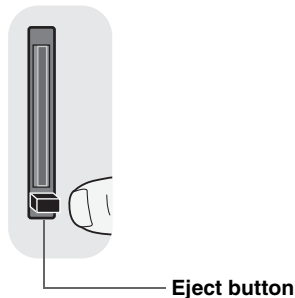

- 2 Pull the CableCARD device straight out of the slot to remove it. To install a different CableCARD device, follow the instructions in “Activating CableCARD Service” on page 20.

When Connecting to Optional Equipment

Front Panel

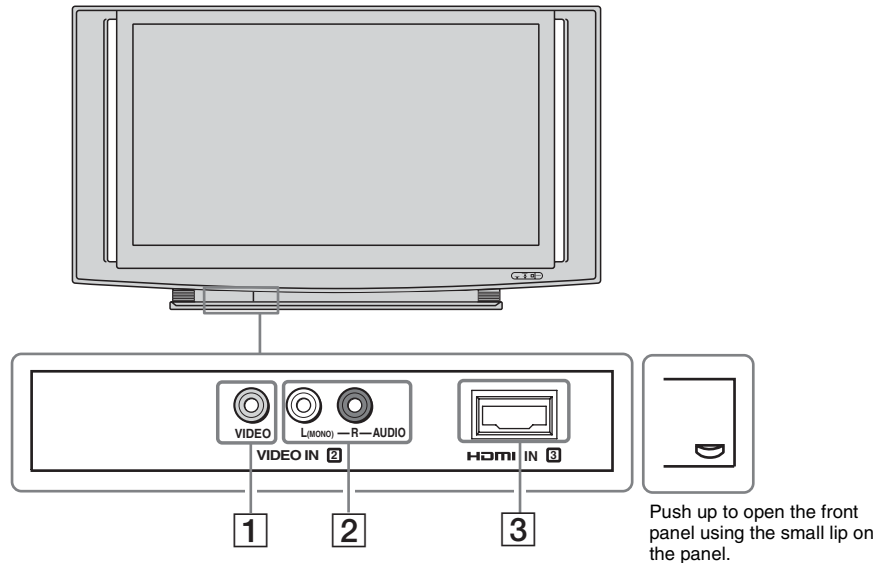

Jack	Description
1 VIDEO IN 2 VIDEO	Connect to the composite video output jacks on your camcorder or other video equipment such as video game equipment.
2 AUDIO IN 2 L (MONO)-R- AUDIO	Connects to the audio (L/R) output jacks of your equipment, including camcorders, video game equipment, to which you want easy access.  If you have mono equipment, connect its audio output jack to the TV's L (MONO) audio input jack.
3 HDMI IN 3	For information about HDMI IN, see page 24.



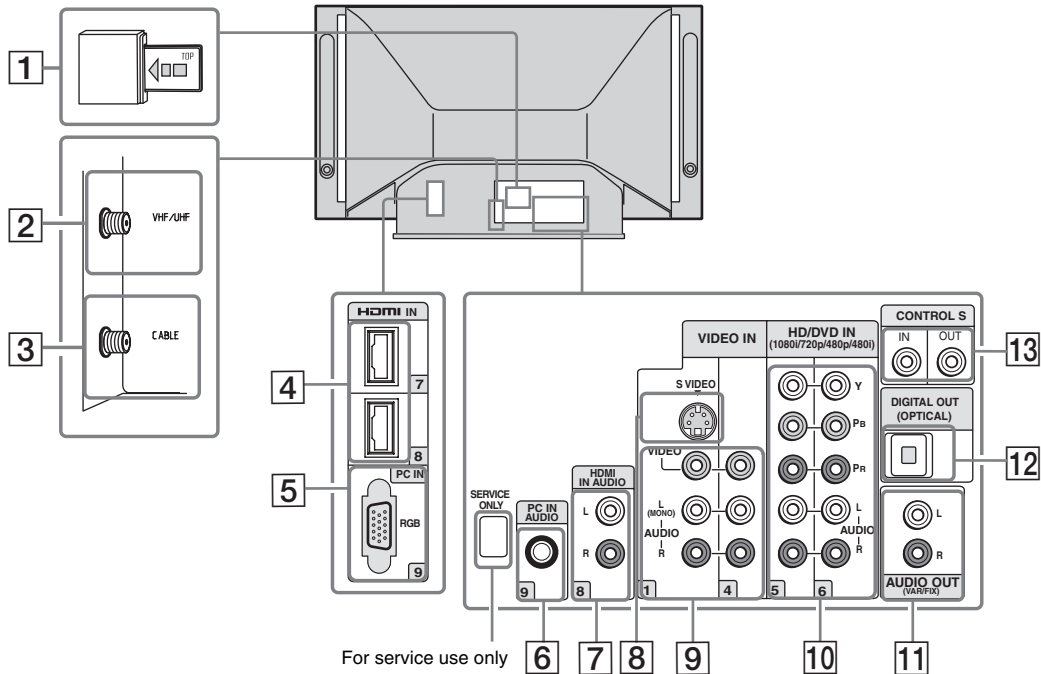



Rear Panel

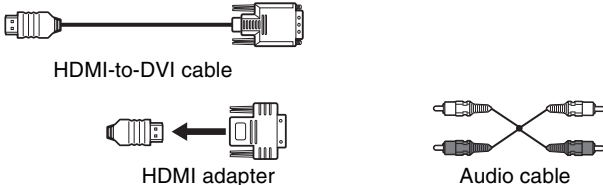

Jack	Description
1 CableCARD slot	CableCARD provides cable subscribers with access to secure, digitally encrypted cable channels — without the need for a set-top box — that will enable you to receive not only standard definition but also high definition television. For details, see page 20.
2 VHF/UHF	Connects to your VHF/UHF antenna.
3 CABLE	Connects to your cable signal. This CABLE input jack, in conjunction with the VHF/UHF input jack, lets you set up your TV to switch between scrambled channels (coming through a cable box) and unscrambled cable channels. For details, see page 16.
	 VHF/UHF input receives over-the-air broadcast signal frequencies and CABLE input receives CATV signal frequencies.

(Continued)

Getting Started

Jack	Description
4 HDMI IN 7/8	<p>HDMI (High-Definition Multimedia Interface) provides an uncompressed, all-digital audio/video interface between this TV and any HDMI-equipped audio/video equipment, such as a set-top box, Blu-ray Disc Player, DVD player, and A/V receiver. HDMI supports enhanced, or high-definition video, plus two-channel digital audio.</p> <p>If the equipment has a DVI jack and not an HDMI jack, connect the DVI jack to the HDMI IN 8 (with HDMI-to-DVI cable and/or adapter) jack (rear panel), and connect the audio jack to the HDMI IN AUDIO 8 (rear panel). (DVI connector is for video signals only.)</p> <div style="text-align: center;">  <p>HDMI-to-DVI cable</p> <p>HDMI adapter</p> <p>Audio cable</p> </div> <div style="background-color: #f0f0f0; padding: 5px;"> <ul style="list-style-type: none">  Be sure to use only an HDMI cable that bears the HDMI logo.  Do not connect a PC to the TV's HDMI input. Use the PC IN (RGB IN) input instead when connecting a PC.  HDMI connection is necessary to view 480i, 480p, 720p, 1080i, and 1080p formats. Note that this TV displays all format types of picture in a resolution of 1,920 dots × 1,080 lines. </div>
5 PC IN 9 RGB	<p>Connect to a personal computer's video output connector using an HD15-HD15 cable (analog RGB, not supplied). Can also be connected to other analog RGB devices. See "PC Input Signal Reference Chart" on page 77 for the signals that can be displayed.</p> <div style="background-color: #f0f0f0; padding: 5px;"> <ul style="list-style-type: none">  For some Apple Macintosh computers, it may be necessary to use an adapter (not supplied). If this is the case, connect the adapter to the computer before connecting the HD15-HD15 cable.  If the picture is noisy, flickering or not clear, adjust the Phase and Pitch of the PC settings, as described on page 65. </div>
6 PC IN AUDIO 9	Connect to the audio output jack on your personal computer.
7 HDMI IN AUDIO 8	Connect to the audio output jack on your DVI-equipped device.
8 VIDEO IN 1 S VIDEO	Connects to the S VIDEO output jack of your VCR or other video equipment that has S VIDEO. S VIDEO provides better picture quality than the composite video (9).
9 VIDEO IN 1/4 VIDEO/ L (MONO)-AUDIO-R	Connect to the composite video and audio output jacks on your A/V equipment such as a VCR or other video equipment. A third composite video and audio jack (VIDEO 2) is located on the front panel of the TV.
10 HD/DVD IN 5/6 (1080i/720p/480p/480i)/ L-AUDIO-R	<p>Connect to your equipment's component video (YPbPr) and audio (L/R) jacks. Component video provides better picture quality than the S VIDEO (8) or the composite video (9) connections.</p> <div style="background-color: #f0f0f0; padding: 5px;"> <ul style="list-style-type: none">  Component video (YPbPr) connection is necessary to view 480i, 480p, 720p, and 1080i formats. Note that this TV displays all format types of picture in a resolution of 1,920 dots × 1,080 lines. </div>

<i>Jack</i>	<i>Description</i>
11 AUDIO OUT (VAR/FIX)	Connect to the left and right audio input jacks of your audio or video equipment. You can use these outputs to listen to your TV's audio through your stereo system.
12 DIGITAL OUT (OPTICAL)	Connects to the optical audio input of digital audio equipment that is PCM/Dolby* digital compatible. (DIGITAL OUT (OPTICAL) is only available for digital channels.)
13 CONTROL S IN/OUT	To control other Sony equipment with the TV's remote control, connect the CONTROL S IN jack of the equipment to the CONTROL S OUT jack on the TV with the CONTROL S cable. To control the TV with the remote control of another Sony product, connect the CONTROL S OUT jack of the equipment to the CONTROL S IN jack on the TV with the CONTROL S cable.

* Manufactured under license from Dolby Laboratories. "Dolby" and the double-D symbol are trademarks of Dolby Laboratories.

Setting Up the Channel List - Initial Setup

After you finish connecting the TV, you can run the **Initial Setup** to create a list of available analog and digital channels. The **Initial Setup** screen appears when you turn on the TV for the first time after hooking it up.

- 1 Press **POWER** on the TV front panel to turn on the TV.

The **Initial Setup** screen appears.



- 2 Press **▲/▼** to highlight the on-screen display language, then press **[OK]**.

The **Date and Time** screen appears.

- 3 Press **▲/▼** to change the numbers, and **◀/▶** to move between fields.

- 4 When you finish setting the date and time, highlight “**OK**” and press **[OK]**.

The message “**Start auto program now?**” appears.

- 5 Press **▲/▼** to highlight “**Yes**” then press **[OK]**.

Auto Program performed through **Initial Setup** will automatically create a list of receivable channels from both **VHF/UHF** antenna and cable TV channels if both sources are connected.

If you choose to set up the channels at a later time, select the **Auto Program** option in the **Channel** settings to scan available channels (see page 56).

After **Auto Program** is complete, you will be prompted to set up the **TV Guide On Screen** system.

 If you select “**No**” during **Initial Setup**, the **Initial Setup** screen will reappear each time you turn on the TV until you complete **Auto Program**.

- 6 After **Auto Program** is complete, press **[OK]** to proceed to the **TV Guide On Screen** system setup.

- 7 When the **Welcome** screen appears, press **[OK]** again to begin the setup.



 Make sure you finish **Auto Program** before starting the **TV Guide On Screen** system setup. If **Auto Program** is not completed, you may not be able to correctly receive program listings.

- 8** After all of the setup steps have been completed, verify the setup information is correct.

If it is, select “Yes” to end setup.

If not, select “No.” The Welcome screen appears. Repeat the setup process to make any corrections.

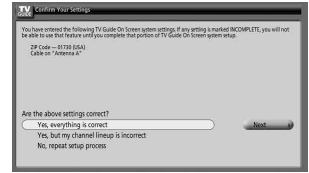

After you set up the TV Guide On Screen system, it may take up to 24 hours to collect program listings. If you press TV GUIDE during this time you will see a setup progress screen. Once program listings are collected, the Guide will appear when you press TV GUIDE.

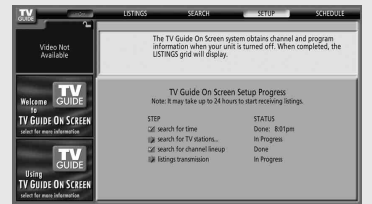

Basic Operations

Remote Control

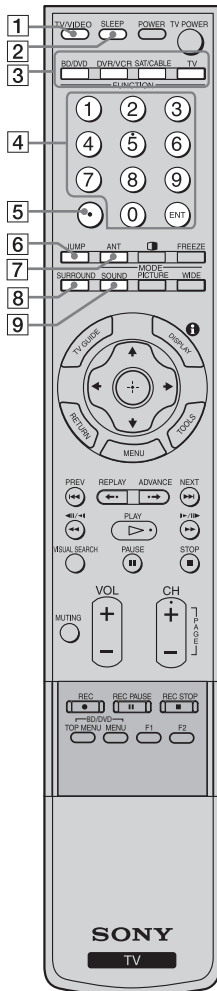

Button	Description
1 TV/VIDEO	Press repeatedly to cycle through the video inputs. See page 60 for information on setting up the video input labels, including the Skip function.
2 SLEEP	Press repeatedly until the TV displays the time in minutes (Off, 15, 30, 45, 60, 90 or 120) that you want the TV to remain on before shutting off. To cancel Sleep, press SLEEP repeatedly until Off appears.
3 FUNCTION Buttons	The FUNCTION button indicator lights up momentarily when pressed to show which external equipment the remote control is operating. When the remote control is set to operate the external equipment, these buttons will operate the equipment you choose. You must first press one of these FUNCTION buttons to operate the corresponding equipment. See page 32 for programming the remote control.
4 0 - 9, ENT	Press 0-9 to select a channel; the channel changes after two seconds. Press ENT to change channels immediately.
5	Use with the 0-9 and ENT buttons to select digital channels. For example, to enter 2.1, press (2), (.), (1) and ENT.
6 JUMP	Press to jump back and forth between two channels. The TV alternates between the current channel and the last channel that was selected.
7 ANT	Press to change between the VHF/UHF input and the CABLE input.
8 SURROUND	Press to select TruSurround XT audio effect or Off to turn this feature off. See page 52.
9 SOUND	Press to cycle through different sound settings: Dynamic for enhanced treble and bass, Standard for spoken dialog and Custom for flat setting.

The 5 button, CH + button and PLAY button have a tactile dot. Use the tactile dot as a reference when operating the TV.

Insert two size AA (R6) batteries (supplied) by matching the and on the batteries to the diagram inside the remote control's battery compartment.

When you use the remote control, point it at the infrared receiver. See page 37 for the location of the infrared receiver.

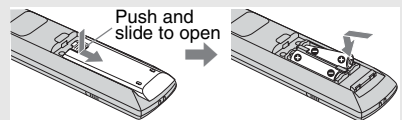

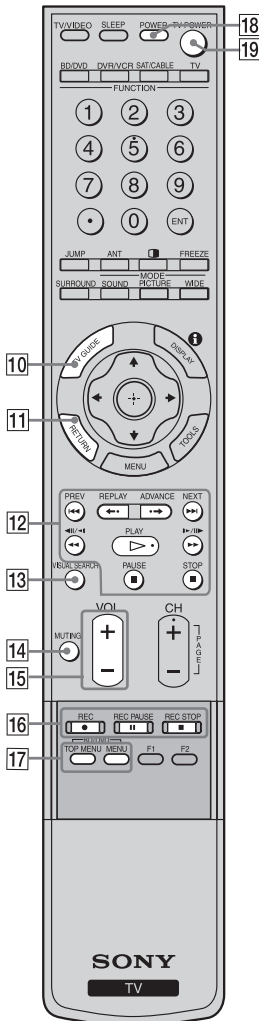

Button	Description
10 TV GUIDE	Press to open the TV Guide On Screen system. Press again to exit the Guide. For instructions on using a specific menu, see “Using the TV Guide On Screen System” on page 38. If the TV is off, then pressing TV GUIDE turns on the TV and opens the TV Guide On Screen system.
11 RETURN	Press to go back to the previous screen when displaying MENU items and settings.
12 BD/DVD, DVR/VCR Operating Buttons	When FUNCTION is switched to BD (Blu-ray Disc)/DVD or DVR/VCR, these buttons operate the video equipment you have programmed into the remote control. For details, see “Using Other Equipment with Your Remote Control” on page 34. ◀◀ PREV: Press to replay the current program from the previous chapter mark (if any) or from the beginning of the live TV cache. ◀◀◀ REPLAY: Press to replay the current program for a set period of time. ▶▶ ADVANCE: Press to advance forward a set period of time when playing back a recorded program. ▶▶▶ NEXT: Press to advance forward to the next chapter mark (if any) or to live TV when playing back a recorded program. ◀◀ (fast reverse): Press to play a program in fast rewind mode. ▷ PLAY: Press to play a program at a normal speed. ▶▶ (fast forward): Press to play a program in fast forward mode. ▬ PAUSE: Press to pause playback. ■ STOP: Press to stop the playback of a recorded program.
13 VISUAL SEARCH	Only for Sony DVD recorders with the visual search function. For details, see the operating instructions supplied with the DVD recorder.
14 MUTING	Press to mute the sound. Press again or press VOL + to restore the sound. <i>🔇</i> The MUTING function is not available when Speaker is set to Off and Audio Out is set to Fixed.
15 VOL +/-	Press to adjust the volume.
16 DVR/VCR Record Buttons	● REC: Press to record. Pressing this button alone starts the recording process. ▬ REC PAUSE: Press to pause the recording. ■ REC STOP: Press to stop the recording.
17 BD/DVD TOP MENU/MENU	Press to display the top menu or menu. <i>📖</i> For further information, refer to the operating manual of the connected equipment.
18 POWER	Press to turn on and off the external equipment selected from the FUNCTION buttons [3].
19 TV POWER	Press to turn on and off the TV.

(Continued)

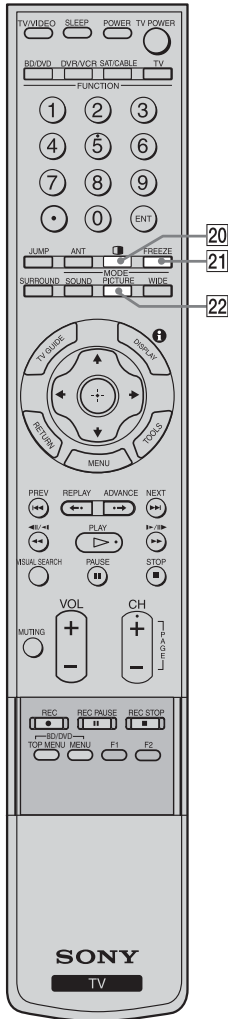

Button Description

20  (Twin View)

Press to toggle Twin View on and off. Twin View lets you see pictures from two sources at once: from an antenna, VCR, DVD, etc.

Activating the Picture

The active picture has a frame around it. To make the other picture active, press \leftarrow/\rightarrow . To change the channel or the input source of the active picture, press CH +/-, 0-9, TV/VIDEO, or ANT.





 If you use a cable box to view all channels, the same channel appears in both windows because the cable box unscrambles and sends only one channel at a time.

 Digital TV channels, as well as any sources connected to the HD/DVD IN 5-6, and HDMI IN 3, 7-8 inputs appear in the left window, but not the right.

Changing the Picture Size

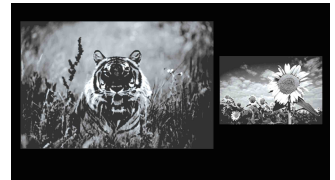
To change the size of a picture, first make sure that it is active. Then, press \uparrow/\downarrow to make the picture bigger or smaller.



 When you adjust the picture sizes in Twin View, the TV memorizes the change. The next time you use the Twin View function, the memorized sizes appear.

21 FREEZE

Press once to display a frozen image of the current program. Press again to return to the program.

Current program in progress

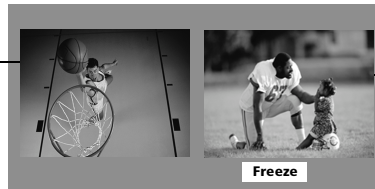

Frozen picture

22 PICTURE

Press repeatedly to cycle through the available picture modes: Vivid, Standard, Custom. The picture modes can be also accessed in the Picture settings. For details, see "Picture Settings" on page 49.

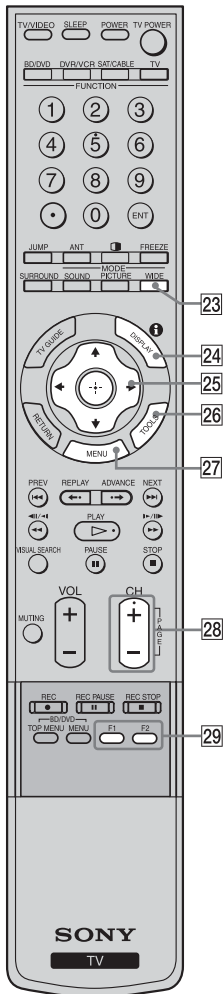

Button	Description
--------	-------------

23 WIDE	Press repeatedly to step through the Wide Mode settings: Wide Zoom, Normal, Full, Zoom. The Wide Mode settings can be also accessed in the Screen settings. See page 54.
----------------	--

Changing the Wide Screen Mode

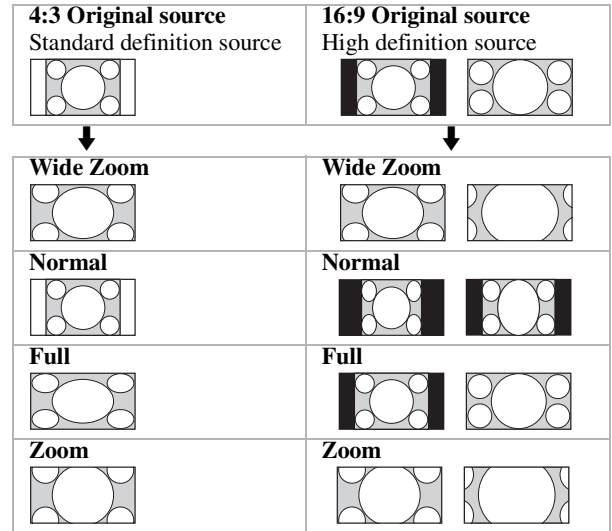

24 DISPLAY	Press once to display the current channel number, channel label, program-related information (if available), time, Wide Mode settings and remaining sleep time (when Sleep is set, see page 61). The OSD (on screen display) will turn off automatically in a few seconds, or you can press DISPLAY again to turn it off immediately.
-------------------	--

When you are using the TV Guide On Screen system, press **DISPLAY** to toggle through small, medium or large options for the size of the Info box.

25	Press to move the on-screen cursor. Press to select/confirm an item.
-----------	--

26 TOOLS	Press to access the Tools menu with commonly used options such as: Twin View , Picture Mode , Sound Mode , Wide Mode , Add to Favorites , Caption Vision (CC) and Alternate Audio .
-----------------	---

The menus you can select may vary depending on the input signal.

27 MENU	Press to display the MENU with TV functions and settings. See “Overview of MENU ” on page 47.
----------------	---

28 CH +/-	Press to scan through channels. To scan quickly through channels, press and hold down either +/-.
------------------	---

29 F1/F2	Press to select the function of connected components. For details, see “Using Other Equipment with Your Remote Control” on page 34.
-----------------	---

Programming the Remote Control

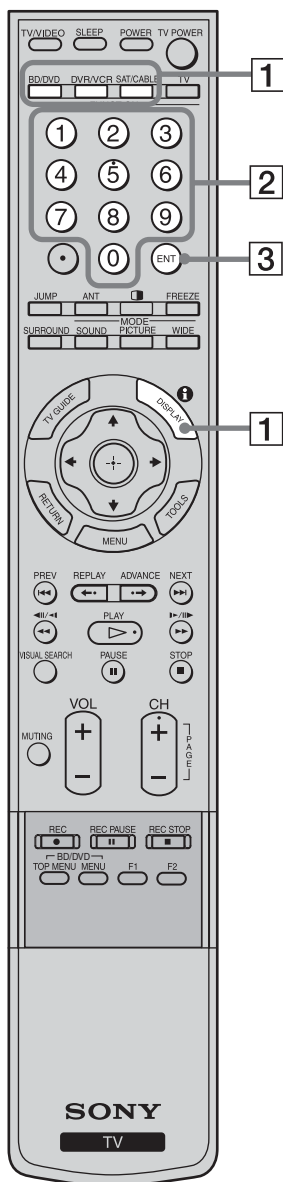

The remote control is preset to operate Sony brand video equipment.

Sony Equipment	Programmable Code Number
BD/DVD	101 (Sony Blu-ray Disc Player)
DVR/VCR	901 (Sony Dream System)
SAT/CABLE	801 (Sony Satellite Receiver)

Follow the steps below to program your TV's remote control to operate non-Sony video equipment.

Find the three-digit code for your equipment from the "Manufacturer's Codes" listed on page 33. If more than one code number is listed, try entering from the code listed first.

- 1 Press and hold the , or FUNCTION button you want to program on the remote control and press the button simultaneously. The selected FUNCTION button (BD/DVD, DVR/VCR or SAT/CABLE) will flash.
- 2 Within 10 seconds (while the FUNCTION button is lit), enter the three-digit manufacturer's code number using the buttons. If the code is not entered within 10 seconds, you must start again from step 1.
- 3 Press the button while the FUNCTION button is lit. When the programming is correct, the selected FUNCTION button blinks twice, and when not, blinks five times.

Although , and buttons are labeled as such, you can still program any of your connected equipment using any one of the buttons regardless of the label. For example, button can be programmed to operate your VCR. If you have a DVD/VCR combo that you want to operate with your TV remote control, you can program with the or or even the , but remember which button you have programmed for your particular use.

To check if the code works

Aim your TV's remote control at the equipment, and press the green button. If you can turn the equipment on and off by using the remote control, then the programming is complete. If not, try the next code listed.

If no code is input within the above specified time, or an invalid or incorrect code number is input, the remote control automatically goes back to the previous setting.

In some cases, you may not be able to program your remote control to operate other equipment. In such cases, use the equipment's own remote control.

Manufacturer's Codes**DVD Players**

Manufacturer	Code
Sony	751, 763
General Electric/RCA	755
Hitachi	758
JVC	756
Magnavox	757
Mitsubishi	761
Oritron	759
Panasonic	753
Philips	757
Pioneer	752, 778
RCA/PROSCAN	755
Samsung	758
Toshiba	754
Zenith	760, 762

DVD/VCR Combo Units

Manufacturer	Code
Sony	767
Broksonic	776
JVC	775
Panasonic	777
Samsung	774
Toshiba	773
Zenith	768

HDD/DVD Combo Units

Manufacturer	Code
Sony	770, 771, 772

DVD Changers

Manufacturer	Code
Sony	765
Panasonic	766

DVR

Manufacturer	Code
Sony	901

Blu-ray Disc Player (BD)

Manufacturer	Code
Sony	101, 102, 103

5.1ch DVD AV System

Manufacturer	Code
Sony (DAV)	601, 602, 603, 604

AV Receivers

Manufacturer	Code
Sony	764

VCRs

Manufacturer	Code
Sony	301, 302, 303 (VHS, 8mm, Beta)

Manufacturer	Code
Sony DV	348
Admiral (M. Ward)	327
Aiwa*	338, 344
Audio Dynamic	314, 337
Broksonic	317, 319
Canon	308, 309
Citizen	332
Craig	302, 332
Curtis Mathes	304, 309, 338
Daewoo	309, 312, 341
DBX	314, 336, 337
Dimensia	304
Emerson	316, 317, 318, 319, 320, 341
Fisher	330, 335
Funai	338
General Electric	304, 309, 329
Go Video	322, 339, 340
Goldstar	332
Hitachi	304, 305, 306, 338
Instant Replay	308, 309
JC Penney	304, 305, 309, 314, 330, 336, 337
JVC	314, 336, 337, 345, 346, 347
Kenwood	314, 332, 336, 337
LG	332
LXI (SEARS)	305, 330, 332, 335, 338
Magnavox	308, 309, 310
Marantz	314, 336, 337
Marta	332
Memorex	309, 335
Minolta	304, 305
Mitsubishi/MGA	323, 324, 325, 326
Multitech	321, 325, 338
NEC	314, 336, 337
Olympic	308, 309
Optimus	327
Orion	317
Panasonic	306, 307, 308, 309
Pentax	304, 305
Philco	308, 309
Philips	308, 309, 310
Pioneer	308
Quasar	306, 308, 309
RCA/PROSCAN	304, 305, 308, 309, 310, 311, 312, 313, 329
Realistic	309, 324, 328, 330, 335, 338
Sansui	314

Manufacturer	Code
Samsung	313, 321, 322
Sanyo	330, 335
Scott	312, 313, 321, 323, 324, 325, 326, 335
Sharp	327, 328
Signature 2000 (M. Ward)	327, 338
SV2000	338
Sylvania	308, 309, 310, 338
Symphonic	338
Tashiro	332
Tatung	314, 336, 337
Teac	314, 336, 337, 338
Technics	308, 309
Toshiba	311, 312
Wards	327, 328, 331, 332, 335
Yamaha	314, 330, 336, 337
Zenith	331

Cable Boxes

Manufacturer	Code
Sony	230
Hamlin/Regal	222, 223, 224, 225, 226
Jerrold/	201, 202, 203, 204,
General Inst./	205, 206, 207, 208,
Motorola	218, 222
Oak	227, 228, 229
Panasonic	219, 220, 221
Pioneer	211, 214, 215
Scientific Atlanta	209, 210, 211
Tocom	216, 217
Zenith	212, 213

Satellite Receivers

Manufacturer	Code
Sony	801
Dish Network	810
Echostar	810
General Electric	802
Hitachi	805
Hughes	804
JVC	810
Mitsubishi	809
Panasonic	803
Philips	811
RCA/PROSCAN	802, 808
Toshiba	806, 807
Samsung	812

* If an Aiwa VCR does not work even though you enter the code for Aiwa, enter the code for Sony instead.

Using Other Equipment with Your Remote Control

To operate other equipment connected to your TV, first turn to page 33 and program the necessary code. For operating video equipment, press TV/VIDEO repeatedly until you see the video input on the screen for your connected equipment. Remote control tips are provided below.

 Some functions cannot be operated depending on the equipment. In that case, operate by the remote control supplied with the equipment.

Operating a Cable Box

To Do This ...	Press ...
Activate the remote control to operate the cable box	SAT/CABLE (FUNCTION)
Turn on/off	POWER

Operating a Satellite Receiver

To Do This ...	Press ...
Activate the remote control to operate the satellite receiver	SAT/CABLE (FUNCTION)
Turn on/off	POWER
Select a channel	0-9, ENT
Change channels	CH +/-
Back to previous channel	JUMP

Operating a VCR

To Do This ...	Press ...
Activate the remote control to operate the VCR	DVR/VCR (FUNCTION)
Turn on/off	POWER
Change channels	CH +/-
Record	●
Play	▷
Stop	■

Operating a DVD Player or DVD Changer

To Do This ...	Press ...
Activate the remote control to operate the DVD	DVD/VCR (FUNCTION)
Turn on/off	POWER
If you have a DVD changer, to skip disc	F1
Play	▷
Stop	■
Pause	(press again to resume normal playback)

To Do This ...	Press ...
Select a channel	0-9, ENT
Change channels	CH +/-
Back to previous channel	JUMP

To Do This ...	Press ...
Display channel number	DISPLAY
Display SAT Guide	TV GUIDE
Display SAT Menu	MENU
Move highlight (cursor)	↑ ↓ ← →
Select item	⊕

To Do This ...	Press ...
Fast forward	▶▶
Rewind the tape	◀◀
Pause	(press again to resume normal playback)
Select a channel	0-9, ENT
INPUT SELECT	TV/VIDEO

To Do This ...	Press ...
Step through different tracks of the disc	◀◀ to fast reverse or ▶▶ to fast forward the disc when pressed during playback
Step through different chapters of the disc	▶▶ to step forward or ◀◀ to step backward
Select a track directly	0-9, ENT
Display the disc menu or top menu	BD/DVD MENU or TOP MENU
Display the system MENU	MENU
Operate the DVD menu	↑ ↓ ← →, ⊕

Operating a Blu-ray Disc Player (BD)

To Do This ...	Press ...
Activate the remote control to operate the Blu-ray Disc Player	BD/DVD (FUNCTION)
Turn on/off	POWER
Play	▷
Stop	■
Pause	⏸ (press again to resume normal playback)

Operating a 5.1ch DVD AV System (Sony DAV)

To Do This ...	Press ...
Activate the remote control to operate the DVD	BD/DVD (FUNCTION)
Turn on/off	POWER
Select other equipment connected to the DAV	F1
Disk skip	F2
Display the disc menu or top menu	BD/DVD MENU or TOP MENU
Select a track directly	0-9, ENT

Operating a DVD/VCR Combo Unit

To Do This ...	Press ...
Activate the remote control to operate the DVD/VCR	DVR/VCR (FUNCTION)
Turn on/off	POWER
Select the DVD Select the VCR	F 1 F 2
Display the disc menu or top menu	BD/DVD MENU or TOP MENU
Play	▷
Stop	■
Pause	⏸

To Do This ...	Press ...
Step through different tracks of the disc	◀◀ to fast reverse or ▶▶ to fast forward the disc when pressed during playback
Display the POP UP menu (BD)	BD/DVD MENU
Display the disc menu (DVD)	BD/DVD MENU
Display the top menu (BD)	BD/DVD TOP MENU
Display the top menu (DVD)	BD/DVD TOP MENU
Operate the menu	⬆ ⬇ ⬇ ⬆, ⊕

To Do This ...	Press ...
Play	▷
Stop	■
Pause	⏸
Search the picture forward or backward	▶▶ or ◀◀ during playback
Specify the previous chapter/track Specify the next chapter/track	◀◀ ▶▶
Move highlight (cursor)	⬆ ⬇ ⬇ ⬆
Select item	⊕
Master volume	VOL +/-, MUTING

To Do This ...	Press ...
Search the picture forward or backward	▶▶ or ◀◀ during playback
Move highlight (cursor) and select (DVD)	⬆ ⬇ ⬇ ⬆ ⊕
Record (VCR)	●
Change channels (VCR)	CH +/- or 0-9, ENT (using tuner)
Adjust tracking (VCR)	CH +/- (during tape playback)
Index search	◀◀ ▶▶
INPUT SELECT	TV/VIDEO

(Continued)

Basic Operations

Operating a HDD/DVD Combo Unit

To Do This ...	Press ...
Activate the remote control to operate the DVD/HDD	DVR/VCR (FUNCTION)
Turn on/off	POWER
Select the HDD Select the DVD	F 1 F 2
Play	▷
Stop	■
Pause	
Search the picture forward or backward	▶▶ or ◀◀ during playback
Move highlight (cursor) and select	↑ ↓ ← → ⊕

Operating an AV Receiver

To Do This ...	Press ...
Activate the remote control to operate the AV Receiver	DVR (FUNCTION)
Turn on/off	POWER

Operating a DVR

To Do This ...	Press ...
Activate the remote control to operate the DVR	DVR/VCR (FUNCTION)
Turn on/off	POWER
Play	▷
Jump back while viewing live or record programs	REPLAY
Slow mode	◀◀/◀◀ (press lightly)
Jump forward while viewing recorded programs	•→

To Do This ...	Press ...
Record	●
REC PAUSE	
REC STOP	■
Specify the previous chapter/track Specify the next chapter/track	◀◀ ▶▶
Replay	←•
Advance	•→
Display the disc menu or top menu	BD/DVD MENU or TOP MENU
INPUT SELECT	TV/VIDEO

To Do This ...	Press ...
Master volume	VOL +/-, MUTING
Select other input connected to AV receiver	F1

To Do This ...	Press ...
Jump forward to the next available chapter	▶▶
Stop	■
Pause	
Record	●
Record Stop	■
Record Pause	

TV Controls

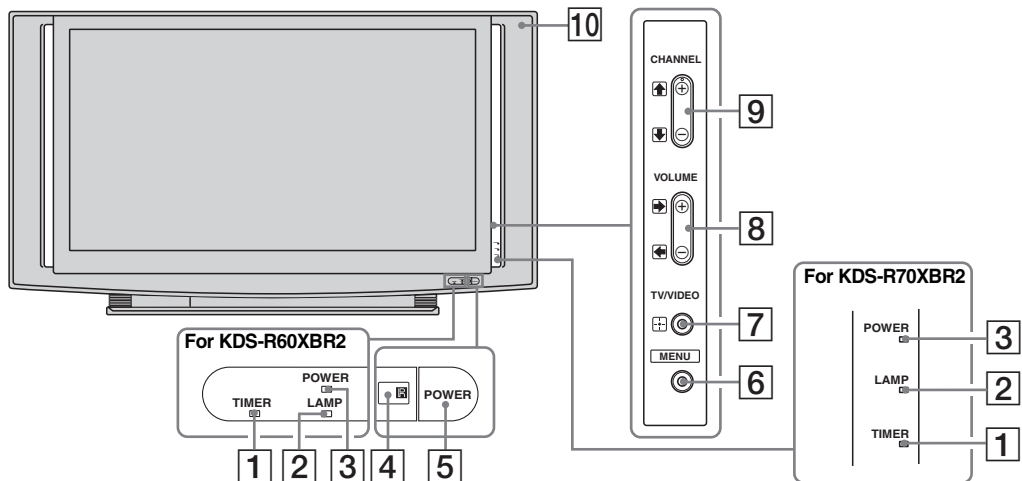

Item	Description
1	TIMER LED When the Guide reminder or timer is set, this LED will remain lit even if the TV is turned off. For details, see pages 45 and 61.
2	LAMP LED Blinks in red when the lamp for the light source has burned out. For details, see “Replacing the Lamp” on page 66.
3	POWER LED Lights up in green when the TV is turned on. If the LED blinks in red continuously, this may indicate the display unit needs servicing (see the contacting Sony information on page 2). When the red LED blinks only three times, the lamp door of the lamp unit or the lamp itself is not securely attached (see page 68).
4	(IR) Infrared Receiver Receives IR signals from the remote control. Do not put anything near the sensor, as its function may be affected.
5	POWER Press to turn on and off the TV.
6	MENU Press to display MENU with TV functions and settings (see “Overview of MENU” on page 47).
7	+/- TV/VIDEO Press to cycle through the video inputs. If you set a certain input to Skip in Label Video Inputs, then the input will not appear. For details, see page 60. In the MENU screen, this button serves as confirming the selection or setting.
8	+/- VOLUME +/- Press to adjust the volume. In the MENU screen, these buttons serve as left/right buttons.
9	+/- CHANNEL +/- Press to scan through channels. To scan quickly through channels, press and hold down either +/- . In the MENU screen, these buttons serve as up/down buttons.
10	Speaker Outputs the audio signal.  The CHANNEL + button has a tactile dot. Use it as a reference when operating the TV.

Using the TV Guide On Screen System

Overview of the TV Guide On Screen System

Your TV features the TV Guide On Screen™ system that provides an 8-day rolling list of TV programming. Use the Guide to find the shows you want to watch. The Guide allows you to search for shows by a variety of program categories, title, actor, director and key word, as well as set reminders for programs you want to watch. The Guide does not require a phone connection, and it's free!





The on-screen interactive TV program guide provides the following main services.

- ❑ **LISTINGS:** Shows the available program listings for the next eight days including today. Provides a description of programs selected.
- ❑ **SEARCH:** Allows you to find shows by keyword or by the following categories: alphabetically, HDTV, movies, sports, children, educational, news, variety, series.
- ❑ **SCHEDULE:** Allows you to review, edit, or delete program reminders that you set previously.
- ❑ **SETUP:** Allows you to make changes in the system settings, channel display and default options after initial Guide setup is completed.

- 🔗 The TV Guide service requires access to selected broadcasts which may not be available in all cases.
- 🔗 The TV Guide On Screen system provides listings for cable-ready TV (including CableCARD service) as well as over-the-air broadcast. It does not provide listings for satellite or cable set-top box services.
- 🔗 For the TV Guide On Screen system to function properly, the TV must be turned off when not in use (such as when you are out of the house or overnight).
- 🔗 The initial Guide setup must be completed before the TV Guide On Screen system is viewed (see page 26 for more information).
- 🔗 Gemstar-TV Guide International Inc. and/or its related affiliates are not in any way liable for the accuracy or availability of the program schedule information or other data in the TV Guide On Screen system and cannot guarantee service availability in your area. In no event shall Gemstar-TV Guide International, Inc. and/or its related affiliates be liable for any damages in connection with the accuracy or availability of the program schedule information or other data in the TV Guide On Screen system.
- 🔗 Although the TV Guide On Screen system offers rating information, the TV Parental Lock features use the rating information in the TV broadcast. This may or may not be the same as the TV Guide On Screen system.

Navigating the TV Guide On Screen System

- 1 Press TV GUIDE to display the Guide.
- 2 Press **▲/▼/◀/▶** to navigate up, down and sideways in the Guide. Once highlighted, press **⊕** to make your selection.
- 3 To choose a service (SCHEDULE, LISTINGS, SEARCH, SETUP) listed on the Service Bar, press TOOLS while in the Guide. Press **◀/▶** to highlight the desired service and press **⊕**. You can also go to the Service Bar by pressing MENU while in the Guide. Select go to Service Bar on the option menu that appears on the left of the Guide.
- 4 Press MENU to view the available options for the service you selected.
- 5 Press TV GUIDE to exit the Guide.









-  When using TV GUIDE to exit, your TV will tune to the last channel you viewed while in the Guide.
-  You can also exit the Guide using RETURN. This will cause your TV to return to the last channel you viewed before entering the Guide. This feature allows you to channel surf in the Guide and still return to your current program.
-  For detailed instructions on how to use a specific service, see page 42-46.
-  The menu options you can use vary depending on the service you selected.

TV Guide On Screen System Components



Approximately 24 hours after the initial Guide setup is completed, you will see this TV Guide On Screen system LISTINGS screen whenever you press the TV GUIDE button on your remote control.

Screen Components	Descriptions
Video Window	Displays the current TV video while the TV Guide On Screen system is displayed.
Clock	Displays the current time.
Lock/Unlock	Allows you to set the Video Window to remain on a single channel (locked) or change channels (unlocked) as you navigate through Listings. Press MENU while Channel logo or Listings Service is highlighted to display the option. Press ←/→ to make the selection then press + .
Service Bar	Provides access to the four main Guide Services. Press ←/→ to scroll to the other services, which include: SCHEDULE, LISTINGS, SEARCH, SETUP. The Current Service Label is displayed with indentation.
Time Slot	Provides program airing time.
Title	Displays the show's title. Highlighted title indicates the active title.

Screen Components	Descriptions
Info Box	Provides information on the highlighted program.
Info Icon	Press DISPLAY to toggle through small, medium or large options for the size of the Info box. The Info Icon will appear if changes, general help or other information are available.
Panel Menu/ Panel Ad	Press MENU to view the Panel Menu, which displays menu items for different services. Panel Ad displays product or show information (advertisement).
Channel Logo/ Number	Displays the channel logo and/or number for easy network identification.
Remind Icon	When an icon is displayed, a reminder will appear on the screen while you are viewing the TV with the set frequency.
	Once Reminds you once for a specific show episode.
	Daily Reminds you for the specified channel and time every Monday through Friday.
	Weekly Reminds you if the show title appears on a specific day of the week on the same channel at a similar start time.
	Regularly Reminds you if the show title appears on any day of the week on the same channel at a similar start time.
	Off (not cancel) Keeps the reminder in TO DO but does not remind you until you reset the frequency.
	Remind Suspended Indicates the program is suspended due to a schedule conflict (show remains in SCHEDULE). When the conflict no longer exists the reminder icon will reappear with the set frequency.
Cancel (no icon displayed)	Select to cancel the reminder. Highlight cancel and press  .
TV Guide Logo	When this icon is displayed, it indicates that the TV Guide On Screen system service is active.
	
Current Service Label	Indicates the current TV Guide On Screen system service that the TV is using.
HDTV Show Icon	When this icon is displayed, it indicates that the program is broadcasting in HDTV.
	
Tile	Displays the specific TV station and program of the current listing.

LISTINGS Service



When the LISTINGS appear, press DISPLAY to show a help screen for detailed guide information. To exit the help screen, press DISPLAY again. Use **▲/▼/◀/▶** to navigate within the LISTINGS.

To Do This...	Do This...
View listings	Press the TV GUIDE button on the remote control. Up to 8 days of program listings can be viewed.
Find out about a program	Use ▲/▼/◀/▶ to highlight the program. The description of the program appears in the window for you to read.
Tune to a program currently airing	Press ⊕ to tune to current show highlighted in listing.
Change the size of the Info box	While highlighting a program, press DISPLAY.
Set a reminder from program listing	Highlight the program for which you want to set a reminder and press MENU. From the Episode Options menu, highlight set reminder to schedule the program.
Adjust the LISTINGS options	While the LISTINGS tab is highlighted, press MENU to view the options that may be adjusted.
Jump hours ahead (While in LISTINGS)	Enter the number on the remote control that corresponds to the number of hours you want to move ahead. The Shortcuts menu appears on the left side of the screen. Press ▶ to view the program listings.
Jump hours back (While in LISTINGS)	Enter the number on the remote control that corresponds to the number of hours you want to move back. The Shortcuts menu appears on the left side of the screen. Press ◀ to view the program listings.
Jump to a channel number (While in LISTINGS)	Enter the number on the remote control of the channel you want to tune to and press ⊕ to jump to your desired channel.
Exit the Shortcuts menu	Press MENU to exit the Shortcuts menu.

SEARCH Service



SEARCH offers a variety of customized search capabilities:

- Category by show type (movies, sports, children, educational, news, variety, series, HDTV)
- Alphabetical by title.
- Keyword by title, actor, director, show description, or all show information.

If the current LISTINGS information does not contain a show in a Guide category or subcategory, that search title is grayed.

To Do This...	Do This...
Search by Category	<ol style="list-style-type: none"> 1 Highlight the show type: MOVIES, SPORTS, CHILDREN, EDUCATIONAL, NEWS, VARIETY, SERIES, HDTV. Then press (+). 2 Press ▲/▼ to highlight a subcategory, and press (+). 3 Do either of the following: <ul style="list-style-type: none"> - If the program is on now, press (+) to watch it. - If the program is on later, press MENU and select the Episode Options menu to set a reminder.
ALPHABETICAL search	<ol style="list-style-type: none"> 1 Highlight ALPHABETICAL, then press (+). 2 Press ▼ to move to the alphabet list and select the first letter of the show you are searching for. Press (+) to display the shows beginning with that letter. 3 Press ▲/▼ to highlight the name of the show, then press (+) to display the times and channels for this program. 4 Press ▼ to highlight an episode. Do either of the following: <ul style="list-style-type: none"> - If the program is on now, press (+) to watch it. - If the program is on later, press MENU and select the Episode Options menu to set a reminder.

(Continued)

To Do This...

KEYWORD search



Do This...

- 1 Highlight KEYWORD and press (+) to display the Keyword Options menu.
- 2 Highlight new search, then press (+). The Search Options menu will appear.
- 3 In the Search Options menu, make the selections for your search. You can specify
 - type (title, actor, director, description, all)
 - category (movies, sports, children, educational, all, etc.)
 - sub (subcategory) (action, animated, comedy, drama, fantasy, all, etc.)Press ←/→ to select a category to search. Highlight enter keyword and press (+) to display the keyboard.
- 4 Highlight a character using ↑/↓/←/→ and press (+) to enter the character. Highlight DONE when finished typing the word and then press (+) to show the list of matching shows for that keyword.
- 5 Press ↑/↓ to highlight the name of the show, then press (+) to display the times and channels for this program.
- 6 Press ↓ to highlight an episode.
Do either of the following:
 - If the program is on now, press (+) to watch it.
 - If the program is on later, press MENU and select the Episode Options menu to set a reminder.

The Guide stores the keywords you create. To edit or delete a keyword, highlight the keyword and press MENU. The Search Options menu is displayed.

The star icon indicates new search results. When the Guide receives new show data, it displays the icon on the Service Bar and all applicable tiles to notify you that new results are available for your stored keyword searches. The icon remains until you review the KEYWORD search screen.

SCHEDULE Service



SCHEDULE offers the functions such as reviewing, editing or deleting the reminders that you previously set.

- 1 Highlight SCHEDULE on the Service Bar.
- 2 Highlight TO DO using \downarrow .
- 3 Press \downarrow to highlight an event and press MENU to display the options in the Panel Menu.

To Do This...	Do This...
Create a new manual reminder	<ol style="list-style-type: none"> 1 Highlight TO DO, then press MENU. 2 Choose new manual reminder and press \oplus. 3 Enter the pertinent information such as date, start and stop time and channel number. 4 Press \oplus to set the event, then select schedule reminder, then press \oplus again to exit the Panel Menu.
Resolve a reminder conflict	When a conflict occurs with the selection you made, a message will appear to let you know the reasons for the conflict. You will have an option to continue or not to proceed with your selection. Highlight your choice and press \oplus . Consider making different event settings.

- When new manual reminder or edit reminder/power on TV is set to yes, the TIMER LED on the front of the TV will light. This LED will remain lit even when the TV is turned off. However, if power on TV is set to no, the LED will not light.
- When new manual reminder or edit reminder/power on TV is set to yes, the TV will turn on when the scheduled program starts and automatically turn off when the program ends. However, if you use any controls, for example, the volume or channel buttons, during this programmed period, the TV will not turn off automatically.
- The reminder information could be lost in case of a power failure.

SETUP Service

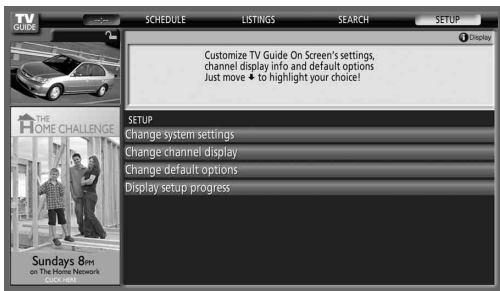

You can customize the TV Guide On Screen system settings. If you have not completed the initial Guide setup, please do so now. This service is only available after you have completed the TV Guide On Screen system setup (see page 26).

To Do This...	Do This...
Change system settings	<p>This option allows you to change or update the current settings of: zip or postal code and cable and/or antenna setup.</p> <ol style="list-style-type: none"> 1 Highlight SETUP in the Service Bar. 2 Highlight Change system settings using \blacktriangledown, then press \oplus. 3 Follow the on-screen instructions.
Change channel display	<p>This option allows you to edit channel information that appears in LISTINGS. The changes you can make are: re-order the position of channel, change the tune channel number, and switch a channel on to always be displayed, off to never display or auto-hide to display only when program information is available.</p> <ol style="list-style-type: none"> 1 Highlight Change channel display and press \oplus. 2 Highlight a channel, then press MENU to display the option menu. 3 Make the changes using $\blacktriangleup/\blacktriangledown$. 4 Highlight done and press \oplus. <p> Note that the channels to which your TV can tune may not be the same channels listed in the TV Guide On Screen system. To modify the channels that appear on your TV, see page 56.</p>
Change default options	<p>This option allows you to make changes in the following default settings: General defaults allows you to set the Info Box size and Auto-Guide feature to turn on or off (default) when the TV is powered on; Remind defaults allows you to select whether to auto tune and adjust reminder time if using auto tune.</p> <ol style="list-style-type: none"> 1 Highlight one of your selections from default and press MENU to display the option menu. Make the changes using $\blacktriangleup/\blacktriangledown$. 2 Highlight done and press \oplus.
Display setup progress	<p>The Setup Progress screen displays the current setup status of your TV.</p>

 The setup information could be lost in case of a power failure.



Using the Menus

Overview of MENU

MENU provides one-button access for controlling your TV. It enables you to perform a variety of tasks intuitively with a control panel on the screen rather than a variety of remote control button presses. When you press the MENU button, you can select from basic TV functions: External Inputs, Favorites, TV Guide On Screen, Cable, Antenna or Settings.



- 1 Press MENU on the remote. The MENU control panel appears.
- 2 Press \uparrow/\downarrow to highlight the item.
- 3 Press \odot to select an option. Press MENU to exit.

-  A dot appears next to the icon of the currently active input (External Inputs, Cable, and Antenna only.)
-  When the TV is displaying the input from a connected PC, the menu only shows PC settings. For more information about PC settings, see page 64.

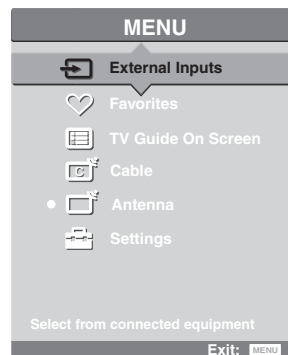

MENU

Description

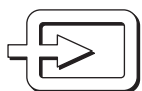

External Inputs







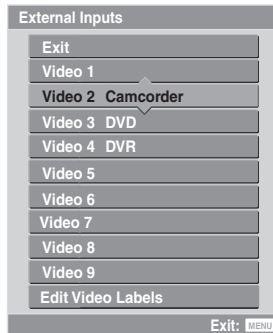







The External Inputs feature lets you select the external inputs connected to your TV. You can also assign a label using Label Video Inputs in the Setup settings (see page 60).

- 1 Highlight External Inputs on the MENU control panel and press \odot .
- 2 Press \uparrow/\downarrow to highlight the desired external input and press \odot .

-  To display the PC settings, select Video 9 in External Inputs. For more information about PC settings, see page 64.



(Continued)

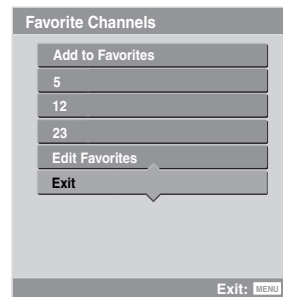

MENU	Description
 <p data-bbox="95 286 194 312">Favorites</p>	<p data-bbox="329 182 913 243">The Favorites feature lets you select programs from a list of up to 16 favorite channels that you specify.</p> <ol data-bbox="329 251 913 477" style="list-style-type: none"> <li data-bbox="329 251 913 338">1 Highlight Favorites from the MENU control panel and press . The Favorite Channels list appears. <li data-bbox="329 347 913 477">2 Make your selection by pressing  to highlight the desired channel and then press . To add the current channel to the list of Favorite Channels, highlight Add to Favorites and press . <p data-bbox="329 486 913 546">To manually edit your favorite channels, select Edit Favorites. For more information, see page 56.</p>
 <p data-bbox="95 651 322 677">TV Guide On Screen</p>	<p data-bbox="329 564 1229 651">The TV Guide On Screen feature displays the TV Guide On Screen system. You can also access the Guide by pressing the TV GUIDE button on the remote control. For details, see “Using the TV Guide On Screen System” on page 38.</p>
 <p data-bbox="95 789 161 815">Cable</p>	<p data-bbox="329 685 1229 746">The Cable feature displays the most recently viewed channel on the cable input. When tuned to the channel, the program banner and channel number will be displayed.</p> <p data-bbox="329 755 1229 815"> To turn on the program banner, select Settings and set the Info Banner option to On in the Setup settings (see page 60).</p>
 <p data-bbox="95 928 188 954">Antenna</p>	<p data-bbox="329 833 1229 894">The Antenna feature displays the most recently viewed channel on the antenna input. When tuned to the channel, the program banner and channel number will be displayed.</p> <p data-bbox="329 902 1229 963"> To turn on the program banner, select Settings and set the Info Banner option to On in the Setup settings (see page 60).</p>
 <p data-bbox="95 1067 188 1093">Settings</p>	<p data-bbox="329 972 1229 1058">The Settings feature lets you enter the settings screen. Settings and adjustments can be performed from the Settings menu. The information on various settings starts from page 49.</p> <p data-bbox="329 1085 665 1111">Navigating Through Settings</p> <ol data-bbox="329 1119 1229 1258" style="list-style-type: none"> <li data-bbox="329 1119 530 1145">1 Press MENU. <li data-bbox="329 1154 504 1180">2 Select . <li data-bbox="329 1189 1229 1215">3 Highlight an item: Picture, Sound, Screen, Channel, Parental Lock, Setup. <li data-bbox="329 1223 692 1249">4 Press  to select an option. <p data-bbox="329 1258 712 1284">To exit the Settings, press MENU.</p> <p data-bbox="329 1293 1229 1354"> The options you can adjust vary depending on the situation. Unavailable options are grayed out or not displayed.</p> <p data-bbox="329 1362 1229 1449"> To display PC settings (page 64), select Video 9 in External Inputs and switch to PC input. Pressing MENU shows PC settings when the TV is displaying the input from a connected PC.</p>

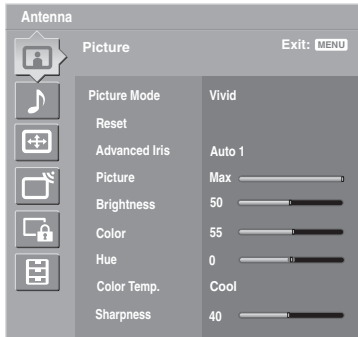

Picture Settings









To display the Picture settings, see “Navigating Through Settings” (page 48).

Option	Description
Picture Mode	Vivid Select for enhanced picture contrast and sharpness.
	Standard Select for standard picture settings. Recommended for home entertainment.
	Custom Allows you to store your preferred settings.
	 You can set up a Picture Mode (Vivid, Standard, Custom) independently for the TV input and for each Video input (Video 1 to Video 8). Your Picture Mode settings are automatically saved upon selection.
Reset	Resets the current settings to default values (except for Advanced Settings).
Advanced Iris	By selecting this option, you can obtain the best brightness and contrast suited for your TV viewing.
	Auto 1/2 Automatically detects the brightness of the screen. This option is best suited for programs that often change between bright scenes and low light setting scenes.
	Auto 1: Recommended option for viewing programs that have larger variation in brightness from scene to scene.
	Auto 2: Recommended option for viewing programs that have less variation in brightness from scene to scene.
	Max With this option, the brightness is about the maximum level.
	High With this option, the screen is at a high level of brightness. It is suitable for TV viewing in a brightly lit room.
	Medium With this option, the brightness is about the standard level.
	Low With this option, the screen is dimmed but contrast is to the maximum. It is suitable for TV viewing in a room with low lighting.
Min With this option, the brightness is about the minimum level.	
 Advanced Iris is not available when you are using Twin View or the Freeze feature.	
Picture	Adjust to increase or decrease picture contrast.
Brightness	Adjust to brighten or darken the picture.

(Continued)

Using the Menus



Option	Description
Color	Adjust to increase or decrease color intensity.
Hue	Adjust to increase or decrease the green tones.
Color Temp. <i>White adjustment</i>	<p>Cool Select to give the white colors a bluish tint.</p> <p>Neutral Select to give the white colors a neutral tint.</p> <p>Warm 1, 2 Select to give the white colors a reddish tint. Available only when Picture Mode is set to Custom.</p>
Sharpness	Adjust to sharpen or soften the picture.
Noise Reduction	<p>Select to reduce the noise level of connected equipment, and the VHF/UHF or cable inputs. Select from Auto, High, Medium, Low and Off.</p> <p> Noise Reduction is not available when you are using Twin View or the Freeze feature.</p> <p> Auto is not available when you are using either HDMI or component connections.</p>
DRC Mode	<p>Produces a high-resolution picture for high-density sources (e.g., Blu-ray Disc Player, DVD Player, satellite receiver).</p> <p>Mode 1 Recommended mode.</p> <p>Mode 2 Only available when the input signal format is 1080i. Use Mode 2 if the original signal is based on a standard-definition signal.</p> <p>Off Select to turn off DRC Mode.</p> <p> DRC Mode is available when you are watching 480i, 480p, 720p or 1080i sources. It is not available when Game Mode is On, when you are using Twin View or the Freeze feature, or when you are watching 1080p sources.</p>
DRC Palette	<p>Custom Allows you to customize the level of detail (Reality) and smoothness (Clarity) for input sources. For example, you can create a Custom setting for your cable input's picture, and create another for your DVD player's picture.</p> <p>1 Press the arrow buttons to highlight Custom then press . The DRC palette appears.</p> <div data-bbox="610 1098 857 1302" data-label="Image"> </div> <p>2 Press the arrow buttons to adjust the position of the marker (●). As you move the ● higher along the Reality axis, the picture becomes more detailed. As you move the ● to the right along the Clarity axis, the picture becomes smoother.</p> <p>3 To save the setting, press .</p> <p> DRC Palette is available when you are watching 480i, 480p, 720p or 1080i sources. It is not available when Game Mode is On, when DRC Mode is Off, when you are using Twin View or the Freeze feature, or when you are watching 1080p sources.</p>

Option	Description	
Advanced Settings <i>Available only when Picture Mode is set to Custom</i>	Reset	Resets all the Advanced Settings to default values (except for White Balance).
	Black Corrector	Enhances black areas of the picture for stronger contrast.
	Gamma	Adjusts the balance between the light and dark areas of the picture.
	Clear White	Emphasizes white and light colors.
	Live Color	Makes colors more vivid.
	White Balance	Adjusts the color temperature color by color.
	Detail Enhancer	Enhances the details of the picture.  Detail Enhancer is not available when you are using Twin View or the Freeze feature.
	Edge Enhancer	Enhances the outline of the picture.

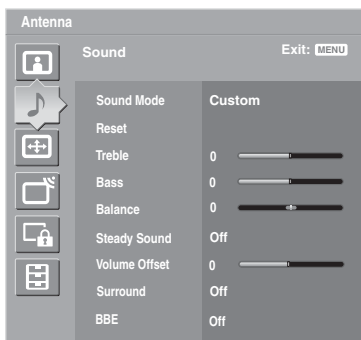
Sound Settings



To display the Sound settings, see “Navigating Through Settings” (page 48).

Option	Description
Sound Mode	Dynamic Select to enhance treble and bass.
	Standard Suitable for spoken dialog.
	Custom Flat setting. Allows you to store your preferred settings.
	 You can set up a Sound Mode (Dynamic, Standard, Custom) independently for the TV input and for each Video input (Video 1 to Video 8). Your Sound Mode settings are automatically saved upon selection.
Reset	Resets the following options to default values: Treble, Bass, Balance, Steady Sound, Volume Offset, Surround and BBE.
Treble	Adjust to increase or decrease higher-pitched sounds.
Bass	Adjust to increase or decrease lower-pitched sounds.
Balance	Adjust to emphasize left or right speaker balance.
Steady Sound	On Select to stabilize the volume across all programs and commercials.
	Off Select to turn off Steady Sound.
Volume Offset	Adjust the volume level of the current input (TV or video input) relative to other inputs.
Surround	TruSurround XT Select for surround sound (for stereo programs only).
	Off Select for normal stereo or mono reception.
BBE	Select to give sound more impact by compensating for phase effects in speakers. Select from High, Low and Off.
	 BBE is available only when Sound Mode is set to Custom.
MTS <i>Enjoy stereo, bilingual and mono programs</i>	Stereo Select for stereo reception when viewing a program broadcast in stereo.
	Auto SAP Select to automatically switch to second audio programs when a signal is received. If no SAP signal is present, the TV remains in Stereo mode.
	Mono Select for mono reception. Use to reduce noise during weak stereo broadcasts.
	 MTS is available only for analog programs. It is not available when you are using Twin View.





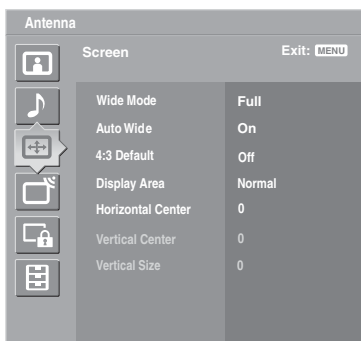







Option	Description	
Alternate Audio <i>Digital channels only</i>		Select to switch among the alternate audio streams. The program you are tuned to may be broadcast in a different language in the alternate audio streams.
		The Alternate Audio option is not available if the program is not broadcast with alternate audio streams.
Speaker	On	Select to turn on the TV speakers.
	Off	Select to turn off the TV speakers and listen to the TV's sound only through your external audio receiver and speakers.
Audio Out <i>Easy control of volume adjustments</i>	Variable	The audio output from your audio system can be controlled by the TV's remote control.
	Fixed	The audio output of the TV is fixed. Use your audio receiver's remote control to adjust the volume (and other audio settings) through your audio system.
A/V Sync <i>Digital channels only</i>	Off/1/2/3	Use this option to make adjustments to audio and video synchronization when you have external equipment connected to DIGITAL OUT of the TV. Select Off (default value) to make no adjustments. Select 1 , 2 or 3 to synchronize the video and audio from your connected external equipment.

Screen Settings



To display the Screen settings, see “Navigating Through Settings” (page 48).



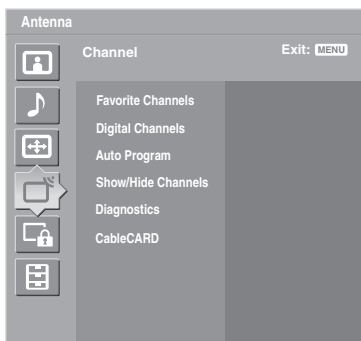

Option	Description
Wide Mode	Wide Zoom Select to enlarge the 4:3 picture to fill the 16:9 screen, keeping the original image as much as possible.
	Normal Select to display the 4:3 picture in its original size when the original source is 4:3. When the original source is 16:9, then the picture may be compressed horizontally.
	Full Select to enlarge the picture horizontally to fill the screen when the original source is 4:3 (standard definition source). When the original source is 16:9 (high definition source), select this mode to display the 16:9 picture in its original size.
	Zoom Select to enlarge the original picture without distorting the aspect ratio.
	 You can set up a Wide Mode (Wide Zoom, Normal, Full, Zoom) independently for the TV input and for each Video input (Video 1 to Video 8). Your Wide Mode settings are automatically saved upon selection. For examples of each mode, see page 31.
Auto Wide	On Select to automatically change to the screen mode that is best for the current program. If frequent screen changes are disturbing to you, select Off.
	Off Select to turn off the Auto Wide option. Choose a screen mode from the Wide Mode option.

Option	Description
4:3 Default <i>Select the default screen mode to use for 4:3 sources.</i>	Wide Zoom Select to enlarge the 4:3 picture, to fill the 16:9 screen, keeping the original image as much as possible.
	Normal Select to display the 4:3 picture in its original size.
	Full Select to enlarge the 4:3 picture horizontally only, to fill the display area.
	Zoom Select to enlarge the picture horizontally and vertically to an equal aspect ratio that fills the wide screen.
	Off Select to continue using the current Wide Mode setting when the channel or input is changed.
<p> 4:3 Default is not available if Auto Wide is set to Off.</p> <p> If 4:3 Default is set to anything but Off, the Wide Mode setting changes only for the current channel. When you change channels (or inputs), Wide Mode is automatically replaced with the 4:3 Default setting. To retain the current Wide Mode setting as channels and inputs are changed, set 4:3 Default to Off.</p>	
Display Area	Allows you to adjust the screen area displaying the picture.
	Normal Select to display the picture in the original size.
	-1/-2 Select to enlarge the picture to hide the edge of the picture.
Horizontal Center	Allows you to move the position of the picture left and right. Press  /  and press  to adjust.
Vertical Center	Allows you to move the position of the picture up and down. (Available only in Zoom.) Press  /  and press  to adjust.
Vertical Size	Allows you to adjust the vertical size of the picture. (Available only in Wide Zoom and Zoom.) Press  /  and press  to adjust.
<p> Size adjustment is especially useful for Wide Zoom picture conditions such as when news ticker information appears at the bottom or top of the screen.</p>	

Channel Settings



To display the Channel settings, see “Navigating Through Settings” (page 48).

Option	Description
Favorite Channels	<p>Lets you set up a list of up to 16 of your favorite channels.</p> <ol style="list-style-type: none"> 1 Press ▲/▼ to scroll to the slot you would like to edit. 2 Enter your favorite channel number and press ⊕ to apply and save. To select other favorite channel numbers, repeat steps 1 and 2. <p> To select favorite channel numbers that you specified, see page 48.</p>
Digital Channels	<p>Add Select to add digital channels.</p>
Auto Program	<p>Automatically sets up the channel list on the TV for all receivable channels for the current TV input (either Antenna or Cable).</p>
Show/Hide Channels	<p>Allows you to show or hide channels that appear in the program guide and when you use the CH +/- buttons to channel surf.</p> <ol style="list-style-type: none"> 1 Press ▲/▼ to highlight the channel that you want to show or hide. To move between the Major and Minor subchannel lists, press ◀/▶. 2 To change a channel’s setting to Shown or Hidden, press ⊕. <p>To show or hide more channels, repeat steps 1 and 2.</p> <p> Channels that you set to be hidden can be accessed only with the 0-9 buttons.</p> <p> If you select to hide or show a major digital channel, all the subchannels are automatically hidden or shown. To show or hide an individual sub-channel within a digital channel, you must individually select that sub-channel to show or hide.</p> <p> If you hide all sub-channels of a major digital channel, that digital channel is automatically set to Hidden.</p> <p> Note that the channels to which your TV can tune may not be the same channels listed in the TV Guide On Screen system. To modify the channels which appear in the program guide, use the SETUP menu of the TV Guide On Screen system (see page 46).</p>
Diagnostics	<p>Display diagnostics information about the current channel and the TV. This can be useful in providing information to an authorized technician or repair person.</p>
CableCARD	<p>This list of selectable CableCARD options will vary, depending on your cable service provider.</p>

Parental Lock Settings

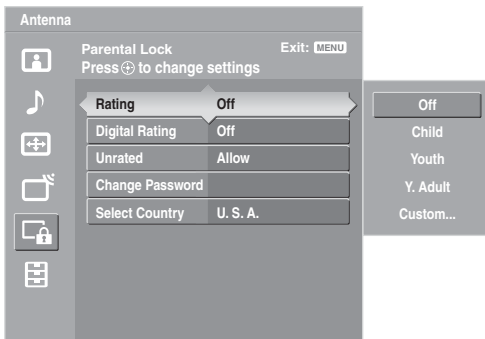

To display the Parental Lock settings, see “Navigating Through Settings” (page 48).

Option	Description
--------	-------------







The Parental Lock settings allows you to set up the TV to block programs according to their content and rating levels. Use 0-9 on the remote control to enter a four-digit password. The first time you create a password, confirm the password by entering it again.

Rating	Off	Turn Parental Lock off. No programs are blocked from viewing.
	Child	Maximum ratings permitted are: U.S.: TV-Y, TV-G, G Canada: C, G, TV-Y
	Youth	Maximum ratings permitted are: U.S.: TV-PG, PG Canada: C8+, PG, 8 ans+, TV-PG
	Y. Adult	Maximum ratings permitted are: U.S.: TV-14, PG-13 Canada: 14+, 13 ans+, TV-14
	Custom...	Select to set ratings manually. U.S.: See page 58 for details. Canada: See page 59 for details.

 If you are not familiar with the Parental Guideline rating system, you should select Child, Youth, or Y. Adult to help simplify the rating selection. To set more specific ratings, select Custom.

(Continued)

Using the Menus

Option	Description
Digital Rating <i>(Available only in U.S.A. where advanced ratings exist)</i>	Off Turn Digital Rating off. No programs that contain downloadable ratings are blocked from viewing.
	Custom... Select to block programs based on downloadable ratings.
	Clear All Select to clear the entire downloadable rating system.
	 Clear All will delete the current Digital Rating menu and the menu will no longer be available until the TV is tuned to a channel that contains downloadable ratings.  This icon  will appear on the information banner across the screen indicating the availability of the new downloadable rating information when the Digital Rating is set to the Custom option.  This setting is only available if digital ratings have been downloaded by your TV and ratings have been set for U.S.A. in the Select Country setting (see below).
Unrated <i>(Available only in U.S.A.)</i>	Allow Allows programs and movies that are broadcast without a rating.
	Block Blocks all programs and movies that are broadcast without a rating.
	 If you block unrated TV programs, be aware that the following types of programs may be blocked: programs broadcast from another country, emergency broadcasts, political programs, sports, news, public service announcements, religious programs and weather.
Change Password	Select to change your password.
	 You need your password for any future access into the Parental Lock settings. If you lose your password, see "Lost password" on page 75.
Select Country	U.S.A. Select to use U.S.A. ratings (see below).
	Canada Select to use Canadian ratings (see page 59).

US Models: Selecting Custom Parental Lock Rating Options

To select custom rating options for the U.S., select U.S.A. in the Select Country setting (see above).

Option	Description
Movie Rating	G All children and general audience.
	PG Parental guidance suggested.
	PG-13 Parental guidance for children under 13.
	R Restricted viewing, parental guidance is suggested for children under 17.
	NC-17 and X No one 17 or under allowed.

Option	Description	
TV Rating <i>Block programs by their rating, content or both</i>	Age-Based Ratings	
	TV-Y	All children.
	TV-Y7	Directed to children age 7 and older.
	TV-G	General audience.
	TV-PG	Parental guidance suggested.
	TV-14	Parents strongly cautioned.
	TV-MA	Mature audience only.
	Content-Based Ratings	
	FV	Fantasy violence.
	D	Suggestive dialogue.
	L	Strong language.
	S	Sexual situations.
	V	Violence.
	 To ensure maximum blocking capability, set the Age-Based Ratings.	

Canadian Models: Selecting Custom Parental Lock Rating Options

To select custom rating options for Canada, select **Canada** in the **Select Country** setting (see page 58).

Option	Description	
English Rating	C	All children.
	C8+	Children 8 years and older.
	G	General programming.
	PG	Parental guidance.
	14+	Viewers 14 and older.
	18+	Adult programming.
French Rating	G	General programming.
	8 ans+	Not recommended for young children.
	13 ans+	Not recommended for ages under 13.
	16 ans+	Not recommended for ages under 16.
U.S.A. Rating	See TV Rating for “US Models” above.	

Viewing Blocked Programs



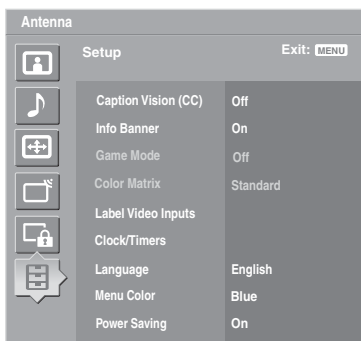

You can view blocked programs by entering the password. Press **ENT** when tuned to a blocked program, then enter the password. This temporarily turns the parental control feature off. To reactivate the **Parental Lock** settings, turn off the TV. When the TV is turned on again, your **Parental Lock** settings are reactivated.

Setup Settings







To display the Setup settings, see “Navigating Through Settings” (page 48).

Option	Description
Caption Vision (CC)	Allows you to select from several closed-caption modes.
	On Caption Vision (CC) is turned on.
	Off Caption Vision (CC) is turned off.
	Program Allows you to set basic and advanced Caption Vision (CC) options. See “Programming Caption Vision (CC)” on page 63.
Info Banner	Set to On or Off. When On, displays the program name and the program information (if the broadcaster offers this service). Displays for few seconds when the channel is changed or the DISPLAY button is pressed.
Game Mode	On Select to optimize for playing games.
	Off Select to turn off Game Mode.
	Game Mode is available when you are watching 480i, 480p, 720p or 1080i sources. It is not available when using Twin View, the Freeze feature, when receiving input from Cable or Antenna, or when you are watching 1080p sources.
Color Matrix	Allows you to select the method for reproducing color-difference signals. It is recommended that you leave this at the factory default value.
	Standard Automatically optimizes based on signal.
	Custom... If the tone of the picture from the input source is unnatural, select either ITU601 or ITU709, which normalizes the tone.
Label Video Inputs	Allows you to identify A/V equipment you connected to the TV, such as a VCR, DVD, etc. For example, if you have a DVD player connected to the VIDEO 4 jack, you can select the label DVD for the Video 4 input. Then when you press TV/VIDEO to change inputs, the video label you assigned to that input appears on screen.
	<ol style="list-style-type: none"> 1 Press / to highlight the video input (Video 1-9) to which you want to assign a label. Then press to select the input. 2 Press / to highlight one of the displayed labels. Then press to select the label. <p>You can select from the following labels for each input:</p>
Video 1-8	—, DVD, Cable Box, Satellite, BD, VCR, Receiver, DVR, Game, Camcorder, Edit, Skip

Option	Description
Video 9	<p>—, PC, Skip</p> <p> Edit allows you to create a custom 10-character label. To edit a label, press ▲/▼ to scroll through the label characters (A-Z, 0-9, etc.). Press ⊕ to move to the next character slot. You can add up to 10 characters.</p> <p> If you select Skip, your TV skips this input when you press the TV/VIDEO button.</p> <p> The Skip label is useful for inputs to which no equipment is connected.</p>
Clock/Timers	<p>Sleep Set the time in minutes (Off, 15 minutes, 30 minutes, 45 minutes, 60 minutes, 90 minutes or 120 minutes) that you want the TV to remain on before shutting off automatically.</p>
Timer 1 Timer 2	<p>You can use the timers to turn the TV on, set the duration time the TV will remain on, and tune to a specific channel at two scheduled times.</p> <p>Timer 1 and Timer 2 will not be available until you set the Current Time.</p> <ol style="list-style-type: none"> Press ▲/▼ to highlight Timer 1 or Timer 2. To set the timer, press ▶. Press ▲/▼ to highlight one of the following options, then press ⊕. Program: Select to set the timer by day, hour, minute, AM/PM, Duration, and Channel. Off: Select to turn off the timer. (Your previous settings are saved.) If you selected Program in step 2, press ▲ and ▼ to set the day(s), hour, minute, AM/PM, duration, and channel number. Press ⊕ or press ▶ to confirm each setting and move to the next setting. Press ◀ to go back to the previous setting. Press MENU to exit Settings.
Current Time	<p>You can set the current time.</p> <ol style="list-style-type: none"> Press ⊕ to select Current Time. Press ▲ and ▼ to set the current time (month, day, year, hour, minute, and AM/PM). Press ⊕ (or press ▶) to confirm each setting and move to the next setting. Press ◀ to go back the previous setting. Press MENU to exit Settings. <p> Current time settings will be overwritten when the TV receives time information from the TV Guide On Screen system.</p>
Time Display	<p>On: Select to enable Time Display, which shows the current time when you press DISPLAY.</p> <p>Off: Select to disable Time Display.</p>
Language	<p>Select to display all on-screen settings in your language of choice: English, Español, Français.</p>
Menu Color	<p>Enables you to select a specific color for the on-screen settings.</p>

(Continued)

Using the Menus

Option	Description
Power Saving	Select to reduce the power consumption by adjusting the lamp brightness. This also enhances the black level. Select Auto , On or Off .
CineMotion	Select Auto to optimize the screen display automatically detecting film content and applying a reverse 3-2 pulldown process. Moving pictures will appear clearer and more natural looking. Select Off to disable the detection.  CineMotion is available for 480i sources, except when you are using Twin View or the Freeze feature.
Cooling Mode	Select High to use the TV at an altitude of 5,000 feet (1,500 m) or higher. Select Normal to use the TV at normal altitude.
Lamp Replacement	When the lamp nears the end of its life, a message appears every time you turn on the TV. After you replace the lamp, select this option and follow the on-screen procedure.  Select this option after you replace the lamp.  Depending on environmental conditions, such as frequency of use, some lamps may burn out before the lamp replacement message appears on the TV.  After the lamp is replaced, you must select this option or this message will continue to appear when you first turn on the TV.
Product Information	Select to display the equipment information of your TV.
TV Guide On Screen	Select to display the TV Guide On Screen system (see page 38).

Programming Caption Vision (CC)

If you selected the Program option under Caption Vision (CC) (see page 60), you can change the following settings:

Option	Description	
Basic	Allows you to select basic analog (EIA-608) closed caption options.	
	CC1, CC2, CC3, CC4	Displays a printed version of the dialog or sound effects of a program. (Should be set to CC1 for most programs.)
	Text1, Text2, Text3, Text4	Displays network/station information presented using either half or the whole screen (if available).
Digital CC	Allows you to set digital closed captioning to Basic (digital EIA-608) or Advanced (digital EIA-708).	
Advanced	Allows you to select advanced digital (EIA-708) closed caption options. Select from the available options.	
Advanced Settings	Allows you to make additional settings for digital (EIA-708) closed caption options. Select from As Broadcast , Small Text , Large Text and Custom .	
	Custom...	Allows you to customize the following settings:
	Character Size	Small, Standard, Large
	Character Style	Style 1-7
	Character Color	Color 1-8
	Character Opacity	Solid, Translucent
	Edge Color	Color 1-8
	Edge Type	None, Raised, Depressed, Outline, Left Shadow, Right Shadow
	Background Color	None, Color 1-8
	Background Opacity	Solid, Translucent
	Window Color	None, Color 1-8
Window Opacity	Solid, Translucent	



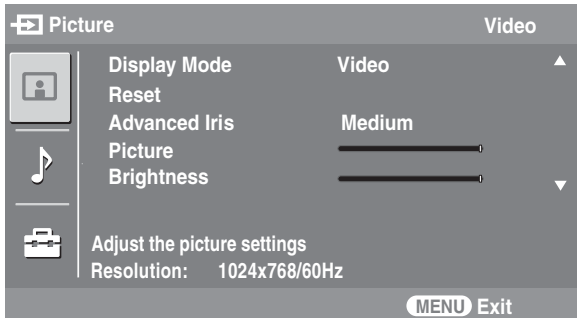





PC Settings



To display the PC settings, see “Navigating Through Settings” (page 48).

Press TV/VIDEO to switch to another input.

Option	Description			
Picture	Display Mode	Video	Select to view video images.	
		Text	Select to view text, charts or tables.	
	Reset		Resets the current settings to default values.	
	Advanced Iris			By selecting this option, you can obtain the best brightness and contrast suited for your TV viewing.
		Auto 1/2		Automatically detects the brightness of the screen. This option is best suited for programs that often change between bright scenes and low light setting scenes.
				Auto 1: Recommended option for viewing programs that have larger variation in brightness from scene to scene.
				Auto 2: Recommended option for viewing programs that have less variation in brightness from scene to scene.
		Max		With this option, the brightness is about the maximum level.
		High		With this option, the screen is at a high level of brightness. It is suitable for TV viewing in a brightly lit room.
		Medium		With this option, the brightness is about the standard level.
Low		With this option, the screen is dimmed but contrast is to the maximum. It is suitable for TV viewing in a room with low lighting.		
Min		With this option, the brightness is about the minimum level.		
		Auto 1 and Auto 2 are not available when Display Mode is set to Text.		
Picture	Adjust to increase or decrease picture contrast.			

Option	Description		
	Brightness	Adjust to brighten or darken the picture.	
	Color Temp.	Cool Select to give the white colors a bluish tint.	
	White adjustment	Neutral Select to give the white colors a neutral tint.	
		Warm 1,2 Select to give the white colors a reddish tint. Warm 2 gives a redder tint than Warm 1.	
Sound	Sound Mode	Dynamic Select to enhance treble and bass.	
		Standard Provides standard sound. Recommended for home entertainment.	
		Custom Provides a flat response. Sound quality as adjusted on the connected PC is maintained in the TV sound.	
Others	Auto Adjustment	Select to automatically adjust the display position, Phase and Pitch of the picture when the TV receives an input signal from the connected PC. Note that Auto Adjustment may not work well with certain input signals. In such cases, manually adjust the options below.	
	Reset	Resets the current settings to default values.	
	Phase	Adjust after Pitch to fine tune overall sharpness.	
	Pitch	Adjust uneven sharpness on screen.  For the PC Input Signal Reference Chart, see page 77.	
	Horizontal Center	Allows you to move the position of the picture left and right. Press   and press  to adjust.	
	Vertical Center	Allows you to move the position of the picture up and down. Press   and press  to adjust.	
	Wide Mode	Normal	Select to display in the original image size.
		Full 1	Select to enlarge the picture to fill the display area, keeping its original ratio.
Full 2		Select to enlarge the picture to fill the display area.  Wide Mode is available only for signals with a 60 Hz vertical frequency.	

Other Information

Replacing the Lamp

The projection lamp, like all lamps, will eventually lose brightness and functionality, which affects the overall performance of your TV. How long the lamp maintains its brightness will vary depending upon your usage and environmental conditions. To maintain the quality of your viewing experience, Sony recommends that you replace the lamp (1) after approximately 4,000 hours of use; (2) when the screen becomes dark or the color looks unusual; (3) when the LAMP LED on the front of the TV blinks; or (4) when the lamp replacement message appears on the TV screen.



WARNING

Electric appliances can cause fire or high temperature, resulting in injury or death. Be sure to follow the instructions below.

- Use the supplied Sony XL-5300 lamp for replacement. Use of any other lamp may damage the TV.
- Do not remove the lamp for any purpose other than replacement. Doing so may cause injury or fire.
- Do not put flammable materials and metal objects inside the lamp receptacle of the TV after removing the lamp. Doing so may cause fire or electrical shock. Do not touch the lamp receptacle once the lamp has been removed.
- When the lamp eventually burns out, you may hear a noticeable pop sound. This is normal and it is inherent to this type of lamp.
- In rare instances, the bulb may pop inside the lamp unit, but the lamp unit is designed to contain all of the broken glass pieces inside the lamp unit.
- This TV's lamp contains mercury and should be disposed of properly. Consult your local authorities regarding safe disposal. The material contained in this lamp are similar to those of a fluorescent lamp, so you should dispose of it in the same way.

How to Replace the Lamp

- 1** Turn off the power on the main unit. Wait several minutes, then unplug the power cord.
(The cooling fan will continue to operate for about two minutes after turning the power off.)
- 2** Wait at least 30 minutes after unplugging the power cord to allow the lamp to cool down before replacing it. To avoid being burned, do not touch the lamp receptacle once the lamp has been removed.

- 3 Take the new lamp out of the box.
Do not touch the glass portion of the new lamp.

- ✎ Do not shake the lamp. Vibration can damage the lamp or shorten its life.
- ✎ Avoid touching the front glass of a new lamp or the glass of the lamp receptacle. This may reduce picture quality or lamp life.

- 4 Remove the outside lamp cover.
Release the clamp as shown in the illustration below.

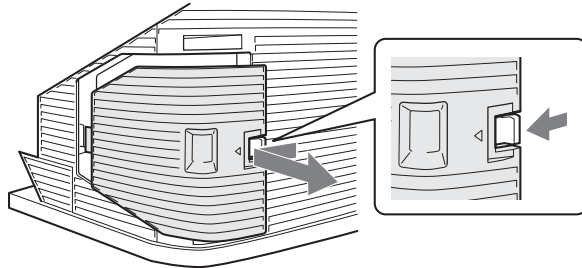

- 5 Remove the lamp door.
Turn the screw counterclockwise, and then turn the knob to the left until the marks on the lid and the case line up. Remove the door.

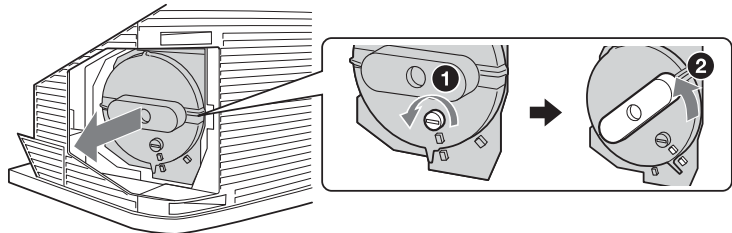

- 6 Pull out the lamp.
Hold the indents on the top and bottom of the lamp, as shown in the illustration, and pull the lamp straight out.

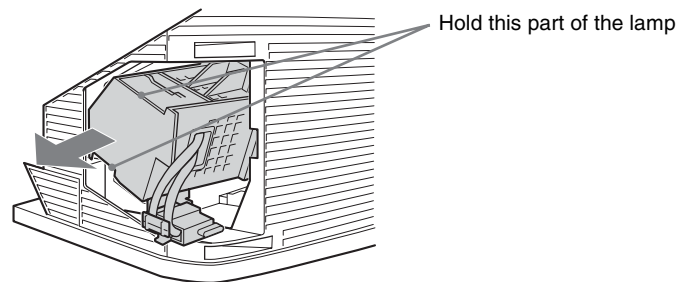

(Continued)

- Do not touch the inside of the lamp compartment.
- The lamp is very hot immediately after use. Never touch the glass portion of the lamp or the surrounding parts.
- After the used lamp has cooled, place it into the empty box of the replacement lamp. Never put the used lamp into a plastic bag.

7 Put the new lamp into its place. Make sure the lamp is securely mounted into the compartment. Failure to do so may cause a fire or the screen to go dark.

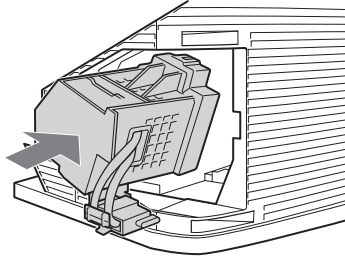

- The lamp compartment is tilted, as shown in the following illustration.

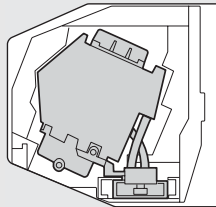

- If the lamp is not securely reattached, the self-diagnostic function may be triggered and the POWER LED blinks three times (see page 37).

8 Reattach the lamp door.

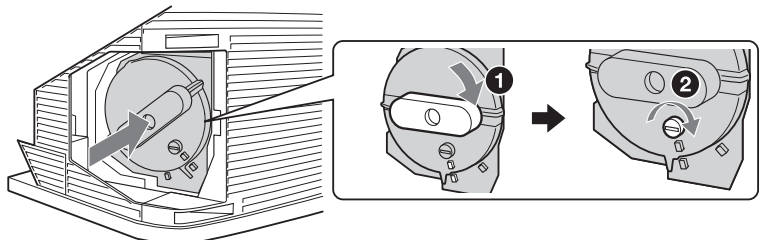

To secure the door, turn the knob to the right while pushing the door in, until the marks on the lid and the case line up. Then, turn the screw clockwise to tighten the door.

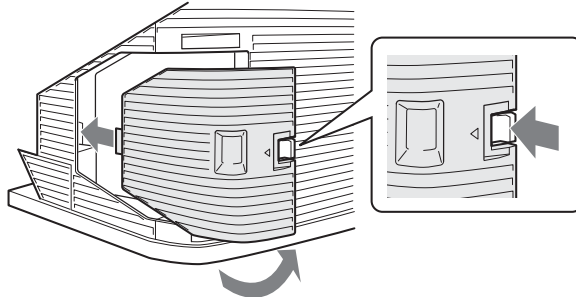

- 9** Put the outside lamp cover back in its place. Replace the cover, inserting it from the left side. Press the clamp on the right side to secure the cover.



- 10** Turn on the TV and set the Lamp Replacement option in the Setup settings (see page 62). This setting is necessary to inform you when the next lamp replacement is needed.

-  Until you set the Lamp Replacement option, a message announcing that the lamp is at the end of its life will appear every time you turn on the TV.
-  Consult your Sony dealer for a Sony XL-5300 replacement lamp.
-  Take great care when replacing the lamp or plugging in/unplugging the connecting cords. Rough handling may cause the TV to fall, damaging the TV, the TV stand and the floor.

The used lamp

For customers in the United States:

This product contains mercury. Disposal of this product may be regulated if sold in the United States. For disposal or recycling information, please contact your local authorities or the Electronics Industries Alliance (<http://www.eiae.org>).

- Do not leave the used lamp near flammable materials or within the reach of children.
- Do not pour water onto the used lamp or put any object inside the lamp. Doing so may cause the lamp to burst.

For replacement lamp information visit:

U. S. residents: <http://www.sonystyle.com/tv/>

Canadian residents: <http://www.sonystyle.ca/tv/>

Troubleshooting

If you have additional questions, service needs, or require technical assistance related to the use of your Sony TV, please visit our website or call one of the following numbers:

<http://www.sony.com/tvsupport>
1-800-222-SONY(7669) for US
1-877-899-SONY(7669) for Canada

TV Guide On Screen System

Problem	Possible Remedies
The TV Guide On Screen system does not show channel lineups nor program listings after initial setup	<ul style="list-style-type: none">❑ It can take up to 24 hours for the TV Guide On Screen system to collect channel lineup and program listings information.❑ The Guide collects data when the TV is turned off (via the POWER button on the remote control or front panel of the TV), so the TV must be turned off for an extended period of time (e.g. midnight to 6 AM) to collect the lineup and listings information. The Guide information is sent multiple times within a day, so that normal TV watching does not interfere with the collection of programming listings.❑ Please check your Cable signal feed is connected to the Cable input on the TV, and likewise, if an Antenna is used to collect over-the-air broadcasts, please make sure the Antenna signal feed is connected to the Antenna input on the TV. The Cable and Antenna feeds must be connected directly to the TV. Cable set-top boxes, for example, may not pass the signal required for the Guide to collect lineup and listings data.❑ Verify the setup information is correct, per Change system settings on page 46.
Listings are missing for some of the days represented in the Guide	<ul style="list-style-type: none">❑ It takes 6 days after initial setup to acquire for all 8 days represented in the Guide. Thereafter, Guide data is updated daily. The TV must be turned off (via the POWER button on the remote control) on a daily basis in order for the listings information to be continually updated.
A channel lineup (channel names, numbers and logos) appears in the LISTINGS screen, but there are no program titles	<ul style="list-style-type: none">❑ If you can see the channel lineup, the Guide is collecting data, but additional time is required to collect the program listings information.
After a power failure, the program listings and current time do not appear	<ul style="list-style-type: none">❑ Turn the TV off using the POWER button on the remote control. New program listings and the current time should become available within 24 hours. Note that the current time information often appears before the program listings.
Some channel numbers in the Guide are incorrect	<ul style="list-style-type: none">❑ Correct the channel numbers using the Change channel display under SETUP service (see page 46).
The TV did not tune to a show that was scheduled with the Reminder feature	<ul style="list-style-type: none">❑ Check the SCHEDULE menu and make sure that the program is listed.❑ Highlight the program under LISTINGS and do the following.<ul style="list-style-type: none">• Press the MENU button on the remote control• Press the ↓ to highlight edit reminder, and press (+).• Make sure that the auto tune option reads yes.

Problem	Possible Remedies
On a dual-feed cable system (“A” and “B” feed), the Guide collects data intermittently	<ul style="list-style-type: none"> <input type="checkbox"/> The TV might be connected to the wrong feed. To test this, try changing the feed when you leave the TV in standby mode (i.e. when you turn the TV off using the POWER button on the remote control or front panel of the TV) to receive the updated Guide data. The Guide only updates data on the feed that originally collected the data. For example, if the Guide collected data on the “A” feed, then you must leave the TV on the “A” feed when you put it in standby mode. If you left the TV on the “B” feed in this example, the Guide would not be able to update any data. <input type="checkbox"/> If, after trying both feeds, the Guide still does not have data, please contact Sony.

Remote Control

Problem	Possible Remedies
Remote control does not operate	<ul style="list-style-type: none"> <input type="checkbox"/> The batteries could be weak. Replace the batteries. <input type="checkbox"/> Check the orientation of the batteries. <input type="checkbox"/> Press TV (FUNCTION) once, and the TV indicator lights up. You may have inadvertently pressed SAT/CABLE (FUNCTION), which changes the remote control to SAT or CABLE mode. <input type="checkbox"/> Make sure this unit’s power cord is connected securely to the wall outlet. <input type="checkbox"/> Fluorescent lamps can interfere with remote control operation; try turning off the fluorescent lamps. <input type="checkbox"/> Keep the remote control sensor area clear from obstacles. <input type="checkbox"/> If the “WARNING: TV temperature is high.” message appears, turn off the TV and wait until the TV’s projection lamp cools down (approximately 5 minutes). If the remote control still does not work, make sure to dust the ventilation slots on the rear of the TV and the cooling fan to provide adequate ventilation around the TV.
Cannot change channels with the remote control	<ul style="list-style-type: none"> <input type="checkbox"/> If you are using the TV to change channels, first press TV (FUNCTION) once, and the TV indicator lights up. <input type="checkbox"/> If you are using another device to change channels, be sure you have not inadvertently switched your TV from the channel 3 or 4 setting. <input type="checkbox"/> If you are using another device to change channels, be sure to press FUNCTION for that device. For example, if you are using your cable box to change channels, be sure to press SAT/CABLE (FUNCTION) once, and the SAT/CABLE indicator lights up.
Remote control does not operate non-Sony video equipment	<ul style="list-style-type: none"> <input type="checkbox"/> If you replaced the batteries to the remote recently, the code numbers for the video equipment may need to be reset. <input type="checkbox"/> There may be more than one code for the equipment that you are attempting to operate. <input type="checkbox"/> There is a possibility that some non-Sony equipment cannot be operated by your Sony TV remote. You may need to use the equipment’s original remote control.

CableCARD Device

Problem	Possible Remedies
Problems using CableCARD device or CableCARD services	<ul style="list-style-type: none"><input type="checkbox"/> Check that the CableCARD is inserted properly (see page 20).<input type="checkbox"/> The CableCARD device must be activated by your local cable TV provider before you can receive digital cable TV services. See the activation instructions on page 20.<input type="checkbox"/> Check the Diagnostics and CableCARD setting options (see page 56). (This can be useful in providing information to an authorized technician or repair person.)<input type="checkbox"/> Contact your cable TV provider.<input type="checkbox"/> If you have moved, ask the CableCARD provider in your new location for a new CableCARD.

Twin View

Problem	Possible Remedies
I cannot get Twin View to work	<ul style="list-style-type: none"><input type="checkbox"/> If you are using a cable box to unscramble all channels (as shown on page 16), you cannot use the Twin View feature. This is because the cable box can unscramble only one channel at a time.<input type="checkbox"/> You can use Twin View to view a signal from a different source that is connected to the TV's A/V jacks (such as a VCR or DVD player) in the second window by pressing TV/VIDEO while in Twin View.<input type="checkbox"/> Sources connected to the VIDEO 3, VIDEO 5, VIDEO 6, VIDEO 7, and VIDEO 8 inputs, as well as digital sources display only in the left Twin View window.<input type="checkbox"/> Twin View is not available when using VIDEO 9 (PC IN).
There is no Twin View window, or it is just static	<ul style="list-style-type: none"><input type="checkbox"/> Be sure the Twin View window is set to a video input or channel that has a signal airing.<input type="checkbox"/> You might be tuned to a video input with nothing connected to it. Try cycling through the video inputs by pressing TV/VIDEO.
Twin View cannot display anything but TV channels	<ul style="list-style-type: none"><input type="checkbox"/> Try cycling through the video inputs by pressing TV/VIDEO. Check that the Label Video Inputs option is not set to Skip. (See the Setup setting on page 60.)
Twin View displays the same program in both windows	<ul style="list-style-type: none"><input type="checkbox"/> Both Twin View windows might be set to the same channel. Try changing channels in either window.

Picture

Problem	Possible Remedies
No picture (screen not lit), no sound	<ul style="list-style-type: none"><input type="checkbox"/> If your TV does not turn on and the POWER LED keeps blinking in red, your TV may need service. Call your local Sony Service Center.<input type="checkbox"/> Make sure the power cord is plugged in.<input type="checkbox"/> Press POWER on the front of the TV.<input type="checkbox"/> Press TV/VIDEO to cycle through the connected video sources.<input type="checkbox"/> Try another channel; it could be station trouble.

Problem	Possible Remedies
Dark, poor or no picture (screen lit), good sound	<ul style="list-style-type: none"> <input type="checkbox"/> Adjust the Picture Mode option in the Picture setting (see page 49). <input type="checkbox"/> Adjust the Brightness option in the Picture setting (see page 49). <input type="checkbox"/> Check the antenna/cable connections.
No color/dark picture/color is not correct	<ul style="list-style-type: none"> <input type="checkbox"/> Adjust the Color option in the Picture setting (see page 50). <input type="checkbox"/> If you set the Power Saving option to On, it will enhance the black level.
The TV turns off automatically	<ul style="list-style-type: none"> <input type="checkbox"/> Check if the Sleep option is activated, or confirm the Duration setting of Timer (page 61). <input type="checkbox"/> If the temperature is too high, the TV may also turn off after a warning message is displayed.
Only snow and noise appear on the screen	<ul style="list-style-type: none"> <input type="checkbox"/> Check the antenna/cable connections. <input type="checkbox"/> Try another channel; it could be station trouble. <input type="checkbox"/> Press ANT to change the input mode (see page 28).
Dotted lines or stripes	<ul style="list-style-type: none"> <input type="checkbox"/> Move the TV away from noise sources such as cars, neon signs, or hair dryers. <input type="checkbox"/> If using 300 ohm twin lead, move the excess lead away from the TV or try using 75 ohm coaxial cable instead.
Double images	<ul style="list-style-type: none"> <input type="checkbox"/> Using a highly directional outdoor antenna or a cable may solve the problem.
“Black box” on screen	<ul style="list-style-type: none"> <input type="checkbox"/> You have selected a text option in the Caption Vision (CC) feature in the Setup setting and no text is available (see pages 60 and 63). To turn off this feature, set the Caption Vision (CC) option to Off. If you were trying to select closed captioning, select CC1 instead of Text 1-4.
Wide Mode changes automatically	<ul style="list-style-type: none"> <input type="checkbox"/> The current Wide Mode setting is automatically replaced with the 4:3 Default setting when you change the channel or video input, if 4:3 Default in the Screen settings is set to other than Off. If you want to lock in the Wide Mode selected with the WIDE button, set 4:3 Default to Off in the Screen settings (page 55). <input type="checkbox"/> Check the Auto Wide option in the Screen settings (page 54).
Black bands appear at the top and bottom of the screen	<ul style="list-style-type: none"> <input type="checkbox"/> Some wide-screen programs are filmed in aspect ratios that are greater than 16:9 (this is especially common with theatrical releases). Your TV will show these programs with black bands at the top and bottom of the screen. For more details, check the documentation that came with your DVD (or contact your program provider).
Certain programs on DVD or other digital sources display a loss of detail, especially during fast-motion or dark scenes	<ul style="list-style-type: none"> <input type="checkbox"/> The compression used by certain digital broadcasts and DVDs may cause your TV's screen to display less detail than usual, or cause artifacts (small blocks or dots, pixelations) to appear on your screen. This is due to your TV's large screen and ability to show very fine detail, and is normal for certain digitally recorded programs. Adjust the Reality/Clarity in the DRC Palette setting (see page 50) to optimize the picture while viewing these sources.

Sound

Problem	Possible Remedies
Good picture, no sound	<ul style="list-style-type: none"><input type="checkbox"/> Press MUTING so that Muting disappears from the screen (see page 29).<input type="checkbox"/> Make sure the Speaker option is set to On in the Sound setting (see page 53).<input type="checkbox"/> Make sure the MTS option is set to Stereo or Mono (see page 52).<input type="checkbox"/> When the HDMI IN input is in use, surround sound, such as AC-3 and DTS, cannot be input. Change the sound setting for the external input device to Linear PCM.
Audio noise	<ul style="list-style-type: none"><input type="checkbox"/> Make sure that the antenna is connected using the 75-ohm coaxial cable.<input type="checkbox"/> Keep the antenna cable away from other connecting cords.<input type="checkbox"/> To avoid TV interference, make sure to use an undamaged antenna cable.
Cannot gain enough volume when using a cable box	<ul style="list-style-type: none"><input type="checkbox"/> Increase the volume of the cable box using the cable box's remote control. Then press TV (FUNCTION) once (the TV indicator lights up) and adjust the TV's volume.
Sound seems weak or insufficient	<ul style="list-style-type: none"><input type="checkbox"/> The TV's audio might be set to Auto SAP or Mono, when it might be better set to Stereo. In the Sound setting (see page 52), set the MTS setting to Stereo. If already set to Stereo, switch to Mono (which may reduce background noise during weak stereo broadcasts).
Cannot raise the volume on external speakers	<ul style="list-style-type: none"><input type="checkbox"/> If the Speaker option is set to Off and the Audio Out option is set to Fixed (in order to output the sound to your audio system), use your audio receiver to adjust the sound (see page 53). Or, to use the TV remote control, set the Audio Out option to Variable.<input type="checkbox"/> To turn on the TV speakers, set the Speaker option to On (see page 53).
No audio for HDMI	<ul style="list-style-type: none"><input type="checkbox"/> Confirm DVD player, set-top box audio settings. Select 2 channel LPCM audio.<input type="checkbox"/> The DVI connector is for video signals only. Connect the DVI jack to the HDMI IN 8 jack, using the HDMI-to-DVI cable and/or adapter. Connect the audio jack to the AUDIO IN (L/R) jacks on the HDMI IN 8 (see page 24).

Channels

Problem	Possible Remedies
Cannot receive upper channels (UHF) when using an antenna	<ul style="list-style-type: none"><input type="checkbox"/> Press ANT to select the VHF/UHF input (see page 28).<input type="checkbox"/> Use Auto Program in the Channel setting to add receivable channels that are not presently in the TV's memory (see page 56).
Cannot receive any channels when using cable TV	<ul style="list-style-type: none"><input type="checkbox"/> Use Auto Program in the Channel setting to add receivable channels that are not presently in the TV's memory (see page 56).<input type="checkbox"/> Press ANT to select the CABLE input (see page 28).
Cannot receive or select channels	<ul style="list-style-type: none"><input type="checkbox"/> Use Auto Program in the Channel setting to add receivable channels that are not presently in TV memory (see page 56).
Some digital cable channels are not being displayed	<ul style="list-style-type: none"><input type="checkbox"/> Certain cable companies have limitations on the broadcast of digital cable channels. Check with your cable company for more information.<input type="checkbox"/> The digital cable channel may be set to Hidden in the Channel setting (see page 56).

General

Problem	Possible Remedies
How to reset the TV to factory settings	<input type="checkbox"/> Turn on the TV. While holding down the ▲ button on the remote control, press the POWER button on the TV. Release the POWER button then release the ▲ button. The TV will turn itself off, then back on again with Initial Setup . WARNING: This operation will clear all of your customized settings including Parental Lock setting.
How to restore Picture settings to factory settings	<input type="checkbox"/> Select Reset setting option while in the Picture setting (see page 49).
How to restore Sound settings to factory settings	<input type="checkbox"/> Select Reset setting option while in the Sound setting (see page 52).
Cannot cycle through the other video equipment connected to the TV	<input type="checkbox"/> Be sure the Label Video Inputs option is not set to Skip (see page 60).
Cannot operate the setting	<input type="checkbox"/> If a setting option appears in gray, this indicates that the setting option is not available.
Lost password	<input type="checkbox"/> On the password screen, enter the following master password: 4357 . The master password clears your previous password; it cannot be used to temporarily unblock channels.
TIMER LED on front panel is lit	<input type="checkbox"/> When lit, indicates that the timer is set (see page 61). Setting reminders in the Guide will also cause the LED to be lit (see page 45). When the timer is set, this LED will remain lit even when the TV is turned off.
POWER LED blinks in red	<input type="checkbox"/> If the LED blinks three times, the lamp door or the lamp might not be securely attached (see page 66). The LED blinks two times if there is an abnormal rise in temperature inside the TV when any ventilation openings are blocked.
LAMP LED blinks in red	<input type="checkbox"/> Replace the lamp (see page 66).
The replacement lamp does not light up	<input type="checkbox"/> The lamp door or the lamp might not be securely attached. Repeat the steps on page 66 to ensure that they are both installed securely.
Digital cable box does not work	<input type="checkbox"/> If you are connecting a VCR and digital cable box using a splitter, as described on page 19, you must use a special bi-directional splitter that is designed to work with your digital cable box. Contact your cable provider for details.
TV cabinet creaks	<input type="checkbox"/> When the TV is in use, there is a natural rise in temperature, causing the cabinet to expand or contract and may be accompanied by a slight creaking noise. This is not a malfunction.
A slight creaking noise occurs from the bottom part of the TV	<input type="checkbox"/> Advanced Iris applies a mechanical iris system. When Advanced Iris is set, a natural creaking noise occurs due to the basic structure of the optical unit. The creaking sound is an inherent nature of this system and is not a defect.
The cooling fan is loud	<input type="checkbox"/> If the TV is used at high altitudes and Cooling Mode is set to High , the cooling fan runs faster and its sound becomes louder. If the TV is not used at high altitudes, set Cooling Mode to Normal (see page 62).
“High Temperature Warning” message appears	<input type="checkbox"/> Make sure to remove dust from the ventilation slots on the rear and both sides of the TV. In addition, make sure that there are no obstacles in front of the ventilation slots, and keep the slots at least 4 inches (10 cm) away from the wall. If the message still appears after the dust or obstacles are removed, the TV may need servicing. Call your local Sony Service Center.

(Continued)

Other Information

Problem	Possible Remedies
The TV does not turn on	<input type="checkbox"/> The TV cools down its projection lamp when the power is turned off. It takes up to two minutes for the picture to come back after the TV is turned on again. Wait for a while until the picture comes back.
Small bright or black dot in picture	<input type="checkbox"/> It may be possible to see several pixels, which appear dark or bright when viewing up close to the screen caused during the manufacturing of the display device. This is not a defect with your TV and will not affect the overall picture performance or reliability of your set. Please view the screen at the recommended viewing distances.
Image left on the screen (image retention)	<input type="checkbox"/> Turn off the TV for a while or let the TV run on another channel. Unlike plasma TV and CRT TV, image retention on this TV <u>is not permanent</u> . It is only a temporary condition; see page 10.
Uneven color uniformity appears on the screen when the TV is powered on	<input type="checkbox"/> After turning on the TV, you may notice a slight variation in color (tint) and brightness in certain areas of the picture. This will last only a few minutes each time you turn on the TV. This is a normal temperature characteristic of the components and not a malfunction.
White spot on the screen when powered off	<input type="checkbox"/> If screen is exposed to direct sunlight or strong ambient light, part of the screen may appear white even when TV is power off. This is due to the strong light reflecting off the TV screen and reflections coming behind the screen. This is a structural property of the projection TV and is not a defect. Position your TV away from such light sources.
“Projection lamp is nearing end of life. Please replace the lamp.” message appears	<input type="checkbox"/> It is time for you to replace the projection lamp used in your TV. <ul style="list-style-type: none">• Turn to page 66 on “How to Replace the Lamp” and follow the directions for replacing the lamp.• Use only the lamp designated for your TV model.• Set the Lamp Replacement option in the Setup settings (see page 62).

PC Input Signal Reference Chart

Resolution	Horizontal (Pixel)	×	Vertical (Line)	Horizontal frequency (kHz)	Vertical frequency (Hz)	Standard
VGA	640	×	480	31.5	60	VGA
	640	×	480	37.5	75	VESA
	720	×	400	31.5	70	VGA-T
SVGA	800	×	600	37.9	60	VESA Guidelines
	800	×	600	46.9	75	VESA
XGA	1024	×	768	48.4	60	VESA Guidelines
	1024	×	768	56.5	70	VESA
	1024	×	768	60.0	75	VESA
WXGA	1280	×	768	47.4	60	VESA
	1280	×	768	47.8	60	VESA
	1280	×	768	60.3	75	VESA
	1360	×	768	47.7	60	VESA
SXGA	1280	×	1024	64.0	60	VESA
	1280	×	1024	80.0	75	VESA
HDTV	1920	×	1080	67.5	60	EIA

- 🔍 This TV's PC input does not support Sync on Green or Composite Sync.
- 🔍 The PC input signal displays on-screen in a smaller size than the actual TV screen size and does not support interlaced signals.
- 🔍 For the best picture quality, it is recommended to use the signals (boldfaced) in the above chart with a 60 Hz vertical frequency from a personal computer. In plug and play, signals with a 60 Hz vertical frequency will be selected automatically.

Specifications

Television system:

NTSC American TV Standard
ATSC (8VSB terrestrial) ATSC compliant 8VSB
QAM on cable ANSI/SCTE 07 2000

Channel coverage:

Terrestrial (analog) 2-69
Cable TV (analog) 1-125
Terrestrial (digital) 2-69
Cable TV (digital) 1-135

Antenna:

75-ohm external terminal for VHF/UHF

Screen size (measured diagonally):

KDS-R60XBR2: 60 inches
KDS-R70XBR2: 70 inches

Projection system

3 SXRD panel, 1 lens projection system

SXRD panel

0.61 inch SXRD panel 6,220,800 pixels (2,073,600 × 3)

Projection lens

High performance, large diameter hybrid lens F2.5

Lamp

Ultra High Pressure Lamp, 180 W, XL-X5300

VIDEO IN 1/2/4:

S VIDEO (4-pin mini DIN) (VIDEO 1 only):
Y: 1.0 Vp-p, 75 ohms unbalanced, sync negative
C: 0.286 Vp-p (Burst signal), 75 ohms
VIDEO: 1 Vp-p, 75 ohms unbalanced, sync negative
AUDIO: 500 mVrms (100% modulation)
Impedance: 47 kilohms

HD/DVD IN 5/6:

YPbPr (Component Video):
Y: 1.0 Vp-p, 75 ohms unbalanced,
sync negative
Pb: 0.7 Vp-p, 75 ohms
Pr: 0.7 Vp-p, 75 ohms
Signal format: 480i, 480p, 720p, 1080i
AUDIO: 500 mVrms (100% modulation)
Impedance: 47 kilohms

HDMI IN 3/7/8:

HDMI: Video: 480i, 480p, 720p, 1080i, 1080p
Audio: Two channel linear PCM 32, 44.1 and
48 kHz, 16, 20 and 24 bits
AUDIO (for HDMI IN 8 only):
500 mVrms (100% modulation)
Impedance: 47 kilohms

AUDIO OUT:

500 mVrms (100% modulation) (Fixed)
More than 1 Vrms at the maximum volume setting (Variable)

DIGITAL OUT (OPTICAL):

Optical Digital Audio Output (PCM/Dolby digital)

PC IN 9:

D-sub 15-pin, analog RGB, 0.7 Vp-p, 75 ohms, positive
See the PC Input Signal Reference Chart on page 77

PC AUDIO INPUT:

Stereo mini jack, 0.5 Vrms, 47 kilohms

Speaker:

Size: ϕ 8 cm (3 ¹/₈ inches) (2)

Speaker output:

15 W + 15 W

Power requirement:

120 V AC, 60 Hz

Power consumption:

In use: 285 W
In standby: Less than 0.2 W

Dimensions (W/H/D):

KDS-R60XBR2: 1674 × 1016 × 514 mm
(66 × 40 × 20 ¹/₄ inches)
KDS-R70XBR2: (with speakers) 1885 × 1154 × 611 mm
(74 ¹/₄ × 45 ¹/₂ × 24 ¹/₈ inches)
(without speakers) 1714 × 1154 × 611 mm
(67 ¹/₂ × 45 ¹/₂ × 24 ¹/₈ inches)

Mass:

KDS-R60XBR2: 55 kg (121 lb.)
KDS-R70XBR2: 73 kg (161 lb.)

Supplied accessories:

Remote control RM-YD009 (1)
Size AA batteries (2)
Side cover (2) (KDS-R70XBR2 only)
Operating Instructions (1)
Quick Setup Guide (1)
Warranty Card (1)
Product Registration Card (1)
Replacement Lamp XL-5300 (1)

Optional accessories:

TV Stand: SU-RS51U
Lamp: XL-5300

 The availability of optional accessories depends on its stock.

Design and specifications are subject to change without notice.

Index

- 0-9 buttons 28
- 4:3 Default 55
- 5.1 Channel DVD using with remote control 35

A

- A/V Sync 53
- Advanced Iris 49, 64
- Advanced Settings 51
- Alternate Audio 53
- ANT button 28
- AUDIO IN jack, described 22
- Audio Out 53
- AUDIO OUT jack, described 25
- Auto Adjustment 65
- Auto Program 56
- Auto Wide 54

B

- Balance 52
- Bass 52
- BBE 52
- BD/DVD MENU button 29
- BD/DVD TOP MENU button 29
- BD/DVD, DVR/VCR Operating buttons 29
- Black Corrector 51
- Blu-ray Disc Player
 - using with remote control 35
- Brightness 49, 65

C

- Cable, CABLE
 - connecting with VCR 18
 - jack, described 23
 - using with remote control 34
- CableCARD
 - device 20, 56
 - slot 23
- Caption Vision (CC)
 - described 60
 - programming 63
- CH +/- button 31
- Change Password 58

- CHANNEL +/- button 37
- Channel Logo/Number 41
- CineMotion 8, 62
- Clear White 51
- Clock 40
- Clock/Timers 61
- Color 50
- Color Matrix 60
- Color Temp. 50, 65
- Connecting
 - Satellite receiver 17
 - VCR 18
- CONTROL S jack, described 25
- Cooling Mode 62
- Current Service Label 41

D

- Detail Enhancer 51
- Diagnostics 56
- Digital Channels 56
- DIGITAL OUT (OPTICAL) 25
- Digital Rating 58
- Display Area 55
- DISPLAY button 31
- Display Mode 64
- DRC Mode 50
- DRC Palette 50
- DVD player
 - using with remote control 34
- DVR/VCR Record buttons 29

E

- Edge Enhancer 51
- English Rating 59
- ENT button 28

F

- F1 button 31
- F2 button 31
- Favorite Channels 56
- FREEZE button 30
- French Rating 59
- FUNCTION buttons 28

G

- Game Mode 60
- Gamma 51

H

- HD/DVD IN jack (1080i/720p/480p/480i), described 24
- HDMI IN jack, described 24
- HDTV Show Icon 41
- High-Definition Multimedia Interface (HDMI) 9
- Horizontal Center 55, 65
- Hue 50

I

- Info Banner 60
- Info Box 41
- Info Icon 41
- Infrared Receiver (IR) 37

J

- JUMP button 28

L

- Label Video Inputs 60
- LAMP LED 37
- Lamp Replacement 62
- Lamp, replacing 66–69
- Language 61
- Live Color 51
- Lock/Unlock 40

M

- MENU
 - Antenna 48
 - Cable 48
 - External Inputs 47
 - Favorites 48
 - Settings 48
 - TV Guide On Screen 48
- MENU button 31, 37
- Menu Color 61
- Movie Rating 58
- MTS 52

(Continued)

MUTING button 29

N

Noise Reduction 50

O

Off, turning off the TV 29, 37

On, turning on the TV 29, 37

P

Panel Menu/Panel Ad 41

Parental Control 8

Password, changing 58

PC IN jack 24

Phase 65

Picture 49, 64

PICTURE button 30

Picture Mode 49

Pitch 65

POWER button 29, 37

POWER LED 37

Power Saving 62

Problems, Troubleshooting 70–76

Product Information 62

R

Rating 57

Remind Icon 41

Remote control

 inserting batteries 28

 programming 32, 33

Removing the CableCARD

 Device 21

Reset 49, 51, 52, 64, 65

RETURN button 29

S

S VIDEO jack, described 24

Satellite receiver

 connecting 17

 using with remote control 34

Select Country 58

Service Bar 40

Settings

 Channel 56

 Parental Lock 57

 PC 64

 Picture 49

 Screen 54

 Setup 60

 Sound 52

Sharpness 50

Show/Hide Channels 56

SLEEP button 28

SOUND button 28

Sound Mode 52, 65

Speaker 37, 53

Steady Sound 9, 52

Support Belt 11

Surround 52

SURROUND button 28

T

Tile 41

Time Display 61

Time Slot 40

Timer

 set current time 61

TIMER LED 37

Title 40

TOOLS button 31

Treble 52

Troubleshooting 70–76

Turning on/off the TV 29, 37

TV GUIDE button 29

TV Guide Logo 41

TV Guide On Screen system

 Components 40

 displaying 62

 LISTINGS 38, 42

 SCHEDULE 38, 45

 SEARCH 38, 43

 SETUP 38, 46

TV POWER button 29

TV Rating 59

TV/VIDEO button 28, 37

Twin View button 30

U

U.S.A. Rating 59

Unrated 58

V

VCR

 using with remote control 34

 with cable, connecting 18

Vertical Center 55, 65

Vertical Size 55

VHF/UHF jack, described 23

Video 1-8 60

Video 9 61

VIDEO IN jack, described 22, 24

Video Window 40

VIDEO/AUDIO (L/R) jacks,
 described 24

Viewing Blocked Programs 59

VISUAL SEARCH button 29

VOL +/- button 29

VOLUME -/+ button 37

Volume Offset 52

W

WEGA Engine 8

White Balance 51

WIDE button 31

Wide Mode 54, 65

Wide Screen Mode 8

